

Europäisches Patentamt  
 European Patent Office  
 Office européen des brevets



(11) EP 1 176 520 A2

(12) EUROPEAN PATENT APPLICATION

(43) Date of publication:  
 30.01.2002 Bulletin 2002/05

(51) Int Cl.7: G06F 17/30

(21) Application number: 01118284.7

(22) Date of filing: 30.07.2001

(84) Designated Contracting States:  
 AT BE CH CY DE DK ES FI FR GB GR IE IT LI LU  
 MC NL PT SE TR  
 Designated Extension States:  
 AL LT LV MK RO SI

(72) Inventors:  
 • Miyasaka, Hitoshi  
 Mountain View, California 94041 (US)  
 • Tanaka, Toshio  
 Shiojiri-shi, Nagano-ken 399-0711 (JP)

(30) Priority: 28.07.2000 US 627350  
 01.11.2000 US 705125

(74) Representative:  
 Grünecker, Kinkeldey, Stockmair &  
 Schwanhäusser Anwaltssozietät  
 Maximilianstrasse 58  
 80538 München (DE)

(71) Applicant: SEIKO EPSON CORPORATION  
 Tokyo 163 (JP)

(54) Providing a network-based personalized newspaper with personalized content and layout

(57) A computer network server provides a customized newspaper to a recipient according to recipient profile preferences. The server searches for and obtains article content that is deemed to be of greatest interest to the recipient according to topical preferences, generates a representation of the selected content according to a layout preference, and delivers the representation

to the recipient according to a designated schedule. Recipient preferences are received and stored in a profile database using facilities that assist a recipient to specify preferred topics, newspaper layout, delivery schedule and destination. Topical designations are mapped into hierarchical structures that facilitate searching content databases. Newspaper articles are arranged according to relative priorities of designated topics.

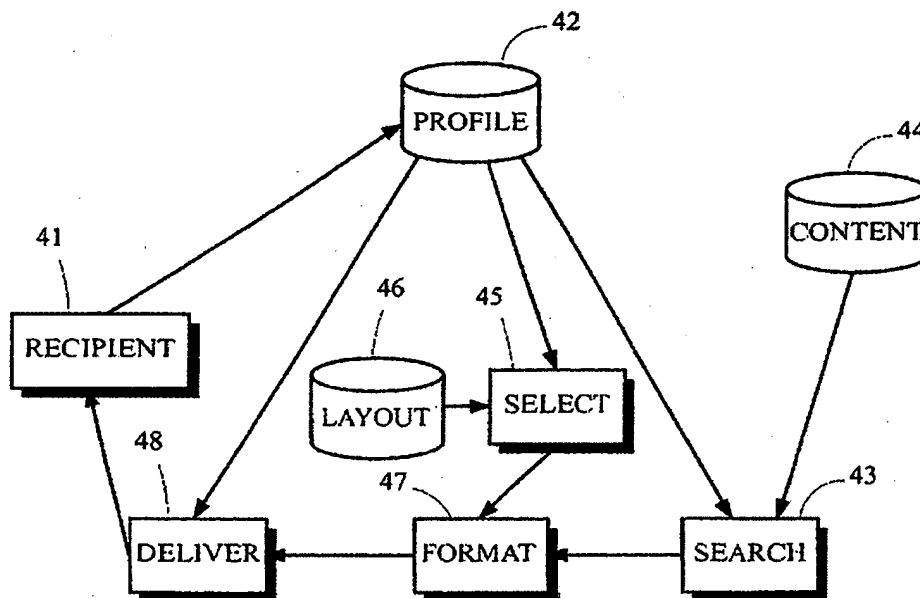

Fig. 1B

Best Available Copy

EP 1 176 520 A2

**Description****TECHNICAL FIELD**

5 [0001] The present invention pertains generally to the use of computer networks, and pertains more particularly to improved ways to access and distribute information to specific recipients through computer networks.

**BACKGROUND ART**

10 [0002] Prior to the wide spread use of global computer networks, many individuals relied on media like newspapers and radio and television broadcasts to obtain "news" or information about rapidly changing situations and current events. Today, global computer networks such as the Internet provide an additional source of information. For some individuals, computer network sources have eclipsed the importance of the older, more traditional media because these networks are capable of supporting extremely rapid publication of large amounts of information. Each document or resource that is made accessible through the Internet, for example, is given a unique identifier or Uniform Resource Locator (URL). As a result, individuals may be given direct access to information from essentially any source throughout the world.

[0003] This has proven to be a mixed blessing. On one hand, having access to large amounts of information is better than having access to only a restricted subset of this information; more is better. On the other hand, the volume of available information has grown to such an extent that most individuals are overwhelmed by the amount of work required to find or identify information of particular interest. It is no longer feasible for individuals to find information by merely perusing global computer networks to discover what exists.

[0004] A number of techniques have been developed in an attempt to solve this problem. One class of techniques "pulls" information to an individual in response to a request. Network facilities called "search engines" assist in the task of finding information by searching for documents and other elements of information that are deemed to satisfy one or more search criteria provided by an individual, and then allowing the individual to request or "pull" selected information from its source. Facilities called "meta search engines" provide an additional level of support by invoking multiple search engines in search of requested information.

[0005] Another class of techniques "pushes" information to an individual in response to a request. Facilities known as "robots" or "agents" assist in the search for information by first identifying information that is pertinent to one or more criteria specified by an individual, and then causing that information to be sent or "pushed" to the individual.

[0006] Although these techniques have achieved some degree of success in finding information, they have not provided facilities for presenting this information in a form that has desirable features like the easily readable layout of a traditional newspaper.

**DISCLOSURE OF INVENTION**

[0007] It is an object of the present invention to provide a computer-network based newspaper having content that can be selected and presented in a form according to personal preferences of an individual recipient.

40 [0008] According to one aspect of the invention, a personalized presentation of news and information is provided to a recipient by obtaining preferences of the recipient, including an indication of one or more preferred categories and a preferred presentation layout; identifying a plurality of documents each having content deemed to satisfy one or more criteria with respect to the one or more preferred categories; generating a list of entries in which each entry corresponds to a respective document in the plurality of documents and delivering an indication of the list to the recipient; receiving from the recipient an indication of selected entries in the list of entries selected by the recipient and identifying one or more selected documents corresponding to the selected entries; obtaining content information that represent at least part of the content of each selected document; and generating a representation of articles including the content information such that a presentation of the representation conforms to the preferred presentation layout.

[0009] According to another aspect of the invention, a method for conducting business includes obtaining preferences of a recipient that include an indication of one or more preferred categories, a preferred presentation layout, and a preferred advertising category; obtaining content information having content in at least one of the preferred categories; and providing to the recipient a printable representation of a newspaper having articles with the content information and having an advertisement with content in the preferred advertising category. A printing of the representation conforms to the preferred presentation layout.

55 [0010] The various features of the present invention and its preferred implementations may be better understood by referring to the following discussion and the accompanying drawings in which like reference numerals refer to like elements in the several figures. The contents of the following discussion and the drawings are set forth as examples only and should not be understood to represent limitations upon the scope of the present invention.

## BRIEF DESCRIPTION OF DRAWINGS

[0011]

- 5 Fig. 1A is a block diagram of a first process that may be used to carry out various aspects of the present invention. Fig. 1B is a schematic diagram of computer and network components that may be used to carry out various aspects of the present invention according to the first process.
- Fig. 2A is a block diagram of a second process that may be used to carry out various aspects of the present invention.
- 10 Fig. 2B is a schematic diagram of computer and network components that may be used to carry out various aspects of the present invention according to the second process.
- Fig. 3 is a schematic illustration of a computer network.
- Fig. 4 is a schematic block diagram of a computer system.
- 15 Figs. 5A-5I are schematic illustrations of forms that may be displayed on a computer display device to receive individual preferences of a recipient.
- Figs. 6A-6C are schematic illustrations of hypothetical relationships between categories, subcategories and keywords.
- Fig. 7 is a schematic illustration of a form that may be used to present a list of suggested articles and to receive recipient selections from that list.
- 20 Fig. 8 is a block diagram of a process that may be used to generate a representation of document content according to a selected layout.
- Figs. 9A-9F are schematic illustrations of hypothetical layouts for a newspaper.

## MODES FOR CARRYING OUT THE INVENTION

25

## A. Overview

[0012] Fig. 1A is a block diagram of method 30 that may be used to carry out various aspects of a first process that provides a computer-network based newspaper having content that can be selected and presented in a form according to personal preferences of an individual recipient. According to this method, step 31 obtains profile information from the individual that defines that individual's personal preferences. In one implementation, the profile includes indications of desired topics for news articles, a selected layout for presentation, and a schedule for providing the newspaper. In this implementation, step 32 and subsequent steps are performed at times specified by the recipient's chosen schedule. Step 32 searches for documents having content that matches the indications of desired topics, and step 33 obtains the content of the documents identified by the search. Step 34 generates a representation of the content of these documents in a format or layout specified in the recipient's profile. Optionally, method 30 includes step 35 that delivers the representation to a destination specified by the recipient. For example, step 35 may send the generated representation by electronic mail (e-mail) to an address included in the profile.

30 [0013] Fig. 1B is a schematic diagram of computer and network components that may be used to carry out various aspects of the present invention according to method 30. In the example shown, information received from recipient 41 is used to construct one or more records of recipient preferences in profile database 42. Search 43 identifies documents in content database 44 having content that matches indications of desired topics in the recipient preferences. A representation of the content of those documents identified by the search is generated by format 47 in a form that conforms to a layout selected from layout database 46 by select 45 according to recipient preferences. In a preferred implementation, deliver 48 sends the formatted representation to recipient 41. In an alternative implementation, the representation is stored for delivery to recipient 41 in response to an explicit request.

35 [0014] Fig. 2A is a block diagram of method 50 that may be used to carry out various aspects of a second process that provides a computer-network based newspaper having content that can be selected and presented in a form according to personal preferences of an individual recipient. According to this method, step 51 obtains profile information from the individual as described above. Step 52 searches for documents having content that matches the indications of desired topics and step 53 builds a list of these documents, which is provided to the recipient in any of several ways discussed below. Step 54 receives from the recipient an indication of which documents represented in the list are selected and step 55 obtains the content of these selected documents. Step 56 generates a representation of the content of these selected documents in a format or layout specified in the recipient's profile. Step 57 delivers the representation to a destination specified by the recipient.

40 [0015] Fig. 2B is a schematic diagram of computer and network components that may be used to carry out various aspects of the present invention according to method 50. In the example shown, information received from recipient 41 is used to construct one or more records of recipient preferences in profile database 42. Search 63 identifies one

or more documents in content database 44 having content that matches indications of desired topics in the recipient preferences. List 69 builds a list of these documents and provides this list to the recipient in any of several ways such as sending the list itself or sending a URL link to a document that contains the list. Subsequently, list 69 receives from recipient 41 an indication of which documents in the list are selected and provides this indication to search 63. A representation of the content of the selected documents is generated by format 47 in a form that conforms to a layout selected from layout database 46 by select 45 according to recipient preferences. Preferably, deliver 48 sends the formatted representation to recipient 41. Alternatively, the representation is stored for delivery to recipient 41 in response to an explicit request.

[0016] Each of the steps for methods 30 and 50 are discussed below in more detail.

[0017] Fig. 3 provides a schematic illustration of a computer network in which various aspects of the present invention may be carried out. In the example shown, news server 5 performs the services described above and illustrated in Figs. 1A, 1B, 2A and 2B. News server 5 obtains documents by subscription through network 1 from content provider 4 and stores these documents in content database 44. Alternatively or in addition, news server 5 may search for and obtain the content of individual documents from databases or other repositories that are maintained by content provider 4 or others. News server 5 formats the content of these documents to provide to each recipient computer system 7-9 a representation of a customized newspaper having content that may be presented according to recipient preferences. Optionally, news server 5 may send the representation to each recipient according to individual scheduling preferences.

[0018] In a preferred implementation, network 1 is a global network such as the Internet, content provider 4 and news server 5 operate as network servers, and the computer system 7-9 for each recipient operates as a network client. In alternative implementations, network 1 may be a local or a regional network, or essentially any other type of data-communication facility. The network servers and clients may be implemented by conventional hardware and software such as that discussed below; however, no particular implementation is critical.

[0019] Fig. 4 is a schematic block diagram of computer system 10 that may be used to carry out various aspects of the present invention as recipient computer 7-9. A similar computer system may be used to carry out various aspects of the present invention in news server 5. CPU 12 provides computing resources. Input control 14 represents an interface to input device 15 such as a keyboard or mouse. Storage control 15 represents an interface to storage device 25 that includes a storage medium such as magnetic tape or disk, an optical medium or solid-state medium. The storage medium may be used to record programs of instructions for operating systems, utilities and applications such as those that can carry out various aspects of the present invention. Display control 16 provides an interface to display device 26 such as a monitor with a cathode ray tube (CRT) or liquid crystal display (LCD) panel. Printer control 17 provides an interface to printer device 27 such as an ink jet or laser printer. RAM 13 is system random access memory (RAM). Comm control 18 provides an interface to communications link 28, which in turn connects to network 1.

[0020] For a network server according to the present invention, computer system 10 may store content, layout specifications, and recipient preferences in storage device 25. Representations of a customized newspaper are sent through comm control 18 to network 1.

[0021] For a network client according to the present invention, computer system 10 may receive representations of a customized newspaper through comm control 18 from network 1 and store the representation in storage device 25 for presentation by display device 26 and/or printer device 27.

[0022] In the example shown in the figure, all major components of computer system 10 connect to bus 11, which may represent more than one physical bus. For example, some personal computers incorporate only one bus that conforms to the so-called Industry Standard Architecture (ISA) or some variant of ISA. Other computers incorporate an additional bus such as a higher bandwidth bus conforming to some bus standard such as the Peripheral Component Interconnect (PCI) local bus standard. A bus architecture is not required to practice the present invention.

[0023] In an alternative apparatus such as one suitable for use as an electronic book, input device 24 could be a set of buttons, storage control/device 15/25 could be some form of solid-state memory, and printer control/device 17/27 could be omitted. Other variations are possible.

[0024] The functions of one or more of these components can be implemented in a wide variety of ways including discrete logic components, one or more ASICs and/or program-controlled processors. The type of implementation is not critical.

## B. Obtain Profile

[0025] Steps 31 and 51 may obtain recipient profile information in essentially any manner. One way is through one or more forms displayed on computer display device 26 of recipient computer 7-9 that permit an individual to enter information that specifies his or her preferences. Schematic illustrations of a set of forms that may be used are shown in Figs. 5A-5G.

[0026] In a preferred implementation, news server 5 requires an individual to setup a subscription by registering individual information in profile database 42. The form shown in Fig. 5A is one example that allows an individual to

register for a new subscription, or to review and modify current preferences for an existing subscription. Forms such as the one shown in this figure as well as the forms shown in other figures may be implemented using a tag-based markup language such as the Hypertext Markup Language (HTML), for example. Other implementations are possible. No particular implementation is critical. In preferred implementations, forms are presented on the screen of display device 26 that guide and assist an individual in using input device 24 to enter and submit information. A wide variety of user interfaces using keyboards, pointing devices and/or touch screens are possible.

**[0027]** Individuals having an existing subscription may review current preferences by entering a "user id" and an associated "password" in the spaces provided and then "clicking" on the "GO" button with a pointing device such as a mouse. In response, news server 5 returns a form such as that shown in Fig. 5G, which gives a registered individual an opportunity to review and modify current preferences. This is discussed in more detail below.

**[0028]** Individuals who wish to register for a new subscription may indicate this by clicking on the "START" button. In response, news server 5 returns one or more forms that allow the individual to enter personal preferences. Examples are shown in Figs. 5B to 5G. Each of these examples may be implemented as an individual form, or essentially any combination may be implemented as portions of the same form. The order and content of these forms is not critical.

**[0029]** The schematic illustration in Fig. 5B indicates the first step for registration is to designate one or more topics of interest. Preferably, the form presents to the individual a list of categories from which topics may be selected. In the example shown in the figure, up to six topics may be specified.

**[0030]** The schematic illustration in Fig. 5C indicates the next step for registration is to optionally specify subtopics and keywords. Preferably, the form presents a list of subtopics pertinent to each designated topic from which the individual may select to further refine the designated topics of interest. This step for registration may use an alternative form, which is illustrated schematically in Fig. 5H. This alternative form allows an individual to specify only one topic or subtopic and optionally one or more keywords.

**[0031]** The schematic illustration in Fig. 5D indicates the next step for registration is to select a preferred format or layout for the newspaper. Preferably, the form presents a graphical representation of each possible layout and allows the individual to specify the size of the type font to use when the newspaper is subsequently displayed or printed.

**[0032]** The schematic illustration in Fig. 5E indicates the next step for registration is to specify a schedule for generation and delivery of the newspaper. In the example shown, the individual may request a newspaper each day, once each week, on weekdays only, or on weekends only. If a weekly schedule is specified, the individual is asked to also indicate the desired day of the week. The individual may also indicate the time of day and the pertinent time zone for generation and delivery.

**[0033]** An alternative implementation of the form shown in Fig. 5E also requests individuals to indicate whether they wish to receive a newspaper having content identified automatically according to the individuals' profile information or whether they wish to receive a newspaper having content they select from a list of suggested articles. If an individual chooses not to select articles from a list, news server 5 may use a method such as method 30 to deliver newspapers to the individual. If an individual chooses to select articles from a list, news server 5 may use a method such as method 50 to provide newspapers to the individual. This distinction is explained in more detail below in conjunction with the discussion of steps 53 and 54 of method 50.

**[0034]** The schematic illustration in Fig. 5F indicates the next step for registration is to specify an e-mail address for delivery, and to provide a "user id" and "password" so that the individual can review and change preferences in the future, yet protect these preferences against unauthorized access and modification.

**[0035]** The schematic illustration in Fig. 5G indicates the last step for registration is to review and optionally change the preferences, and to confirm the desire to register by clicking on the "REGISTER" button. Alternatively, the individual may avoid registering by clicking on the "CANCEL" button.

**[0036]** Registered individuals may use the form shown in Fig. 5G, or may use a form similar to it, to review and modify current preferences. By clicking the "Change Topics" button, news server 5 can present to the individual the forms shown in Figs. 5B and 5C so that he or she can change the designated topics, subtopics and keywords. After the desired changes are made, news server 5 can present the form illustrated in Fig. 5G so that the individual can make additional changes. After all changes are made, the individual can either click on the "REGISTER" button to save the changes or click on the "CANCEL" button to discard the changes and preserve the current preferences.

**[0037]** In a preferred implementation, an additional step is required to confirm registration. This step comprises news server 5 sending an e-mail message to the address specified in step 5, discussed above in connection with Fig. 5F. The body of this message asks the individual to return the message to the sender to confirm the registration. When news server 5 receives the message, the registration is confirmed and the subscription is processed according to the individual's preferences as stored in profile database 42. This additional step may be used to validate the e-mail address for subsequent newspaper deliveries.

**C. Search for Content**

[0038] Steps 32 and 52 identify documents and other information that are likely to have content most appealing to an individual by searching for the content that matches the indications of preferred topics stored as part of the individual's profile. In preferred implementations, an individual is allowed to enter one or more preferred topics or subtopics and keywords.

**1. Multiple Topics and Subtopics**

[0039] Figs. 6A-6C are schematic illustrations of hypothetical relationships between topics, subtopics and keywords. The structure shown in Fig. 6A includes a designation of the "domestic" topic, which indicates a preference for domestic news. The structure includes designations for the "agriculture" and "weather" subtopics, which indicate a particular preference for domestic news related to agriculture and weather. Designations of keywords for "water," "rice" and "cotton" further refine the indicated preference for agricultural news, and designations of keywords for "rain" and "temperature" further refine the indicated preference for weather-related news.

[0040] The distinction between topics, subtopics and keywords is somewhat arbitrary. A classification that is classified as a subtopic in one implementation may be classified as a topic or a keyword in other implementations. No particular classification is critical to the present invention; however, in preferred implementations, preferred topics, subtopics and keywords are transformed into another hierarchical structure as necessary so that they conform to the searching and indexing requirements of the content stored in content database 44.

[0041] The searching and indexing requirements may vary according to the source of the content. For example, content obtained through subscription to Associated Press (AP) Online is classified according to a set of category codes specified by the American Newspaper Publishers Association (ANPA), and further classified according to a set of categories specified by AP Online. The ANPA categories are shown in Table I.

Table I

ANPA Code	Category or Classification
a	Domestic
e	Entertainment
f	Financial / Business
i	International
p	Elections
q	Sports scoreboard and schedule
s	Sports stories, game summaries
v	Advisories
w	Washington

[0042] The "domestic" topic designated in the hierarchical structure shown in Fig. 6A corresponds to the "Domestic" category provided by the ANPA specification; however, the remaining elements in the hierarchical structure do not all map to a respective AP Online classification. The AP Online set of classifications does not include any classification that is related specifically to the subtopic "agriculture" but it does include several classifications that are related to the subtopic "weather" as shown in Table II. There are no corresponding classifications for any of the keywords.

Table II

AP Online Code	Category or Classification
1201	National weather and temperature tables
1202	Foreign temperature tables
1204	Other -- weather roundups

[0043] Fig. 6B illustrates a mapping that may be used to transform part of the structure shown in Fig. 6A into a suitable set of search requirements for content received from AP Online. As shown, the designated topic "domestic" corresponds to an existing ANPA category but the designated subtopic "agriculture" and the designated keyword "rice," for example, are both mapped into keywords for searching. In other words, the specified preferences shown in Fig. 6A are transformed by the mapping illustrated in Fig. 6B into criteria that are suitable for searching content received from AP Online. According to this set of criteria, documents having content that is classified as "domestic" (ANPA code

"a") are searched for occurrences of the words "agriculture" and "rice." In another implementation, synonyms and other words related to keywords could be included automatically in the search. For example, the keyword "farming" could be included in the search because it is related to "agriculture."

5 [0044] Fig. 6C illustrates another mapping that may be used with content that is classified according to a hypothetical scheme that includes a category for "U.S. agriculture." In yet another example not shown in the figures, all levels of hierarchical topics that are designated by an individual may need to be mapped to keywords, or to categories defined by the content provider. In preferred implementations, however, individual preferences are entered through forms that restrict the choice of topic and subtopic to classifications defined by the content provider.

10 [0045] One way in which this mapping may be carried out is to construct a table that cross-references all of the topics and subtopics that can be designated by an individual with the corresponding categories defined for the content. Multiple tables may be used if content is available from more than one source, or if content is available that is classified according to more than one classification scheme. A mapping to synonyms and other related words may be implemented in the same manner.

15 [0046] In one implementation, the transformation may be carried out by ignoring the designated topic and mapping the designated subtopic into a corresponding search category, provided a corresponding category is defined for the content to be searched. If the designated subtopic does not correspond to a defined category, the designated topic is mapped into the corresponding search category and the designated subtopic is treated as a keyword. After the preferred topics and subtopics designated by an individual have been mapped into a suitable set of criteria, a search for content in content database 44 may be easily carried out according to those criteria. No particular searching or indexing technique is critical.

20 [0047] The results of the search may be used to derive a measure of recipient interest, which is an estimate of the degree to which a specific document has content that will appeal to an individual. Essentially any combination of several factors may be taken into account.

25 [0048] One factor is the relative priority of the topic. If an individual is allowed to rank topics such as that discussed above and shown in Fig. 5B, a document having content that pertains to the highest rated topic will be given a higher measure of interest than will be given to a document with content that pertains to a lower ranked topic, all other factors being equal.

30 [0049] A second factor is whether a document has content that pertains to one or more subtopics. In one implementation, a document with content that pertains to a topic and one or more associated subtopics is given a higher measure of interest than another document having content that pertains only to the topic but not a subtopic.

35 [0050] A third factor is the number of occurrences of keywords. Generally, a larger number of occurrences indicates a higher measure of interest. Preferably, occurrences of keywords are either ignored or discounted if those keywords are associated with a topic or subtopic in the recipient's preferences that is not pertinent to the document content. In the example shown in Fig. 6A, the occurrences of the keyword "rice" in a document about weddings would not be given the same consideration as occurrences in documents having agricultural content.

[0051] A fourth factor is the location of keywords within a document. Preferably, a document having a keyword within a headline or possibly within the first paragraph of the body of the document, for example, is given a higher measure of interest than a document having the keyword occur only at other locations.

## 40 2. Single Topic or Subtopic

[0052] The processes performed by news server 5 to search for document content and to derive measures of recipient interest can be simplified by restricting individual preferences to one topic or subtopic for each newspaper. Preferably, an individual may request more than one newspaper but the content of each newspaper is limited to a single topic or subtopic. This allows an individual to specify different delivery options for different types of newspapers. For example, an individual could request week-day delivery of a business-news newspaper, and could request weekend delivery of a leisure-oriented newspaper.

45 [0053] Fig. 5H provides a schematic illustration of a form that may be used during registration to have an individual specify one topic or subtopic. This form corresponds to the form shown in Fig. 5B for an implementation that permits an individual to specify multiple topics and subtopics. Preferably, the form allows an individual to specify one or more keywords to further refine the topic or subtopic of interest.

50 [0054] A search for document content may be carried out in a manner similar to that described above for multiple topics and subtopics. The results of the search may be used to derive a measure of recipient interest in a document by using such factors as the number and/or location of occurrences of keywords within a document, as discussed above.

## 55 D. Selection

[0055] As mentioned briefly above, an implementation of news server 5 may allow individuals to choose whether

they wish to receive a newspaper having content selected automatically according to the individuals' profile information or whether they wish to receive a newspaper having content they select from a list of suggested articles. If an individual chooses not to select content from a list, news server 5 may use a method such as method 30 to provide the newspaper. The results of the search carried out in step 32 are used to select the content automatically. If an individual chooses to select content from a list of suggested articles, news server 5 may use a method such as method 50 to provide newspapers to that individual. Steps 53 and 54 present the list and receive the selection, respectively.

[0056] Step 53 uses the results of the search carried out in step 52 to build the list of suggested articles. Preferably, the articles in the list are arranged according to some measure of recipient interest so that the articles deemed to be of greater interest are arranged ahead of other articles. For example, articles having a larger number of occurrences of keywords can be listed ahead of other articles having fewer occurrences of keywords. Each item in the list may include the title and source of an article with some indication of how the content of that article relates to the individual's preferred topics, subtopics and keywords.

[0057] Step 53 may provide the list to the individual recipient in a variety of ways. In one implementation, the list is built as an HTML document and sent to the individual as an attachment to an e-mail message. Each item in the list of this document contains a link or other reference to the corresponding article that is stored in some database such as content database 44. In another implementation, the list document is stored by a server such as news server 5 and a link or other reference to the list document is sent to the individual by e-mail. The individual can access the list document by using appropriate software such as a browser to navigate the link to the list document.

[0058] A schematic illustration of an example of a list document is shown in Fig. 7. In this example, the relevant topic or subtopic is displayed above the list, and each item in the list includes the title of the corresponding article and a "check box" that the individual can use to indicate his or her selections. As this example shows, the list can include articles having a variety of content. The first, third and fifth articles in the list have news content. The second article is an image that, in this example, pertains to the first article in the list. The fourth article is an advertisement. In an alternative implementation, the list document includes miniature or "thumbnail" representations of images.

[0059] Step 54 receives the individual's selections from the list build in step 53. In the example discussed above and illustrated in Fig. 7, a selection is made by clicking on the appropriate check box. The first, second, third and fourth articles have been selected. The illustrated form in this example provides an optional feature that allows an individual to select all suggested articles in the list by clicking on the "ALL" button, and allows the individual to clear or reset all selections by clicking on the "CLEAR" button. After selecting the articles of interest, the individual can instruct news server 5 to generate and deliver a representation of a newspaper with the selected articles by clicking on the "GO" button.

#### E. Obtain Content

[0060] Step 33 obtains the content of the documents or other information that was identified by step 32. Step 55 obtains the content of the documents or other information that was selected in step 54. This content may be obtained very easily if the content itself is stored in content database 44. Alternatively or in addition, some content may reside elsewhere such as in a content server connected to network 1. In this situation, search requests may be submitted to the content server or it may be possible to service the search request using an index or other information structure immediately available to news server 5. For example, an index to a remote content server may be stored in content database 44. If a search identifies documents or other information on the content server that have content of interest to a recipient, that content may be retrieved by submitting a "get" or retrieval request to the content server. In response, the content server may return the requested content to news server 5 for use in preparing a newspaper. If permitted, the requested content may also be stored in content database 44 for subsequent use.

#### F. Format Content

[0061] Steps 34 and 56 format the content obtained by steps 33 and 55, respectively, for presentation to the intended recipient. The form of the presentation is generated to conform to a preferred layout specified in the recipient profile.

[0062] The representation itself may be generated according to essentially any computer file format including the Portable Document Format (PDF), word processor formats such as WordPerfect® or Microsoft® Word, international facsimile formats, bit-mapped images, or native printer formats such as the Printer Control Language (PCL). In preferred implementations that generate representations for presentation on display device 26, the representation is generated in PDF. In alternative implementations that generate representations for presentation only by printer device 27, the representation is generated in a native printer format or in some encrypted form, described below.



## 1. Formatting Process

[0063] Fig. #8 is a block diagram of method 80, which represents one way in which steps 34 and 56 may be carried out. Step 81 performs various initialization activities such as selecting the desired layout from layout database 46 and obtaining a list of areas in the selected layout that is ordered according to priority. Content of the document that is deemed to be of greatest interest to the intended recipient is to be formatted in the area having the highest priority. Document content deemed to be of progressively lower interest is formatted in areas having progressively lower priority.

[0064] Step 82 is part of an outer loop structure and is performed reiteratively. In the first iteration of this loop, step 82 selects the area that has the highest priority. In subsequent iterations, step 82 selects the area from the list that has the next highest priority. An area may be defined for multiple pages; however, in preferred implementations, each area is confined to one page.

[0065] Step 83 is part of an inner loop structure and is performed reiteratively to obtain the content of a respective document from a set of documents that are considered to be of interest to the intended recipient. In the first iteration, step 83 obtains the content of the document deemed to be of greatest interest to the recipient. In subsequent iterations, step 83 obtains the content of the document that is deemed to be of the next greatest interest.

[0066] Step 84 is an optional step that associates the selected document with one or more graphical objects such as pictures. This step is desirable in those implementations that format articles to include text and graphics from content of documents having either textual content or graphical content, but not both. The size of the graphical object is altered as necessary to optimize the use of space in the selected area of the layout. More than one graphical object may be associated.

[0067] Step 85 adds dictionary items to textual content. The dictionary items are provided for a specified language according to the reading proficiency of the recipient in the language of the document content.

[0068] Step 86 analyzes the combined content of the selected document, associated graphics and dictionary items to determine what portion can fit in the selected area of the layout. A representation of that portion is generated.

[0069] If a representation of the combined content of a document, graphics and dictionary items does not fill the selected area, step 87 obtains filler material to fill the remaining space in the area. If the representation of the combined content exceeds the space of the selected area, step 87 may generate a representation of all or some of the remaining content in another area, preferably on another page.

[0070] Step 88 determines whether the formatting process for the selected area is done. In some implementations, designated areas are allowed to include brief representations of more than one document. The inner loop structure provides for representations of multiple documents to be included in an area. If formatting for the selected area is not yet complete, the method continues with step 83, which obtains content of the next most important document. If processing for the area is complete, the method continues with step 89, which determines whether the processing for all formatting is complete. If not, the method continues with step 82, which selects the area having the next highest priority; otherwise, method 80 terminates.

[0071] Various aspects of method 80 are described below in more detail.

## 2. Selected Layout

[0072] Figs. 9A to 9F provide schematic illustrations of several hypothetical layouts for the first page of a newspaper. In these examples, the portion labeled "BANNER" represents the name of the newspaper and any other information such as date that is independent of document content.

[0073] Referring to Fig. 9A, the area denoted "ARTICLE 1" represents a portion of the page in which all or part of the content of a first document is to be presented when displayed or printed. The area denoted "ARTICLE 2" represents a portion of the page in which all or part of the content of a second document is to be presented when displayed or printed. In preferred implementations, the first and second documents are the ones deemed to have the greatest and next greatest measures of interest for the recipient, respectively. As mentioned above, a variety of techniques may be used to rank documents according to predicted measures of recipient interest or interest. Alternatively, the documents may be presented in any arbitrary order such as by alphabetic order of document content title, date/time order specified by the content provider, or order in which the content is stored in content database 44.

[0074] The area denoted "BRIEFS" represents a portion of the page in which only a small part of each of multiple documents is to be presented. For example, "briefs" may present only the first paragraph of each document. In preferred implementations, the documents selected for presentation in the BRIEFS section are those documents that are deemed to be of less interest than the documents presented elsewhere on the page. An implementation may provide in each "brief" a URL link to the full content of the document.

[0075] In preferred implementations, documents that have more content than can be presented in a designated area of a page may be processed in either of two basic ways. One way divides the document content into first and second parts such that a presentation of the first part fits in the designated area and all or a portion of the second part is

presented on a subsequent page. Preferably, some indication such as "Go to page XX" is included with the presentation of the first part to refer to the page on which the second part is presented.

[0076] A second way divides the document content such that a presentation of a first part of the content fits in the designated area and the remaining content is omitted. Preferably, some indication of the omission such as "More" or "Remainder omitted" is included in the article presentation. A document name or some document-access information such as a URL link for the full content of the document may be provided.

[0077] Optionally, the recipient may be allowed to specify a maximum or preferred length of an article presentation, which could cause part of the second part to be omitted. If part is omitted, the presentation could include some indication of omission as described above. The length may be specified in essentially any manner such as the number of characters, number of lines, number of paragraphs, number of columns or column-inches, or number of pages.

[0078] A "maximum" article length specifies a certain limit on a presentation. A "preferred" article length allows some flexibility in the process that generates the presentation. For example, the length of an article presentation may be allowed to exceed a preferred length under certain conditions such as, for example, when document content can be presented in its entirety in a space that only slightly exceeds the preferred length by some specified margin, or when a document is given a very high measure of recipient interest.

[0079] Figs. 9B to 9F illustrate other layouts in which some provide areas denoted "ARTICLE 3" and "ARTICLE 4" for presenting the content of third and fourth documents in a manner similar to that described above for the first and second documents.

[0080] The layouts in Figs. 9E and 9F include an area designated "AD" in which an advertisement or other notice may be presented. The content of this area may be selected in a manner that is independent of recipient preferences; however, preferably content is selected according to what is estimated to be of greater interest to the recipient. This selection may be based on individual preferences in the recipient profile that are used to search for document content. In a preferred implementation, the recipient is presented with a form during the registration process that requests an indication of advertising category preference and, optionally, one or more keywords. A schematic illustration of a form that may be used for this purpose is shown in Fig. 51. By obtaining recipient preferences for advertising, news server 5 can incorporate advertisements into each newspaper that are much more relevant or of much greater interest to the recipient. It is anticipated that operators of news server 5 can charge higher fees for such targeted advertising than can be charged possible for generic advertising. These fees can be used to defray costs of providing the newspaper, thereby reducing or eliminating any charge to the recipient.

[0081] The area designated "CPN" in the layout illustrated in Fig. 9F represents an area in which a coupon or rebate certificate may be presented to encourage the recipient to print the newspaper. For example, the CPN presentation could be a coupon that the recipient could use to obtain discounts or rebates for printing supplies such as paper, ink or toner. Preferably, the printed representation of the coupon or the business arrangement in which the coupon is used should discourage or prevent someone making or using photocopies of the coupon.

### 3. Graphical Content

[0082] Generally, content providers such as AP Online furnish documents that contain either text or graphical objects like pictures, but not both. In preferred implementations, a recipient is allowed to indicate a preference for a newspaper with all text and no graphics, with no text and all graphics, or with some intermediate mix of text and graphics. For those presentations that include graphics, a number of additional features can greatly improve the quality of the newspaper format.

[0083] The first feature uses the search results of steps 32 and 52 to associate information with graphical content with other information having textual content. Many content providers like AP Online do not provide documents with both text and graphics; therefore, it is often necessary for news server 5 to make this association. One way in which this may be done is by searching the captions that often accompany graphical content in the same manner as is done for textual content, and to use the results of these searches to identify instances of text and graphic information that are closely related. The various measures of recipient interest discussed above may be used to assess how closely graphical content is related to textual content.

[0084] The second feature adjusts the size of a graphical object to optimize the use of space in the presentation of a newspaper page. Generally, the presentation of a graphical object will not be satisfactory unless the ratio of height to width, sometimes referred to as the aspect ratio, is preserved. In preferred implementations, the width of a graphical object such as a picture is adjusted to match the width of one or more columns of text, -and the height is adjusted to preserve the aspect ratio. In one implementation, the width of a graphical object is set equal to one less than the total number of columns used to present an article. If an article is formatted to print in three columns, for example, the width of an associated graphical object is set equal to the width of two columns and the height is set to preserve the original aspect ratio. In a second implementation, the width of a graphical object is set equal to the width of one column of text.

[0085] The third feature controls the number of graphical objects and/or the size of graphical objects according to

recipient preferences. If a recipient indicates a higher or lower preference for graphical content, the size and/or number of objects is set higher or lower, respectively.

[0086] The fourth feature allows the recipient to specify the desired spatial resolution of graphical and/or textual presentations to balance a number of competing factors such as the capacity of the representation that must be received and stored, the time and cost required to print the representation, and the subjective quality of the presentation. Another feature allows the recipient to specify whether a presentation includes color or is limited to a monochromatic or so called "black and white" representation.

#### 4. Filling an Area

[0087] In preferred implementations, documents that have slightly less or slight more content than can be presented in a designated area of a page may be processed in a number of ways. One way increases or decreases the size of the type font to increase or decrease the amount of space needed for the presentation, respectively. Other ways increase or decrease the spacing between lines and or the size or margins.

[0088] In yet another way, a document having less content than can be presented in a designated area can be augmented by adding filler material to fill out the designated area. In this context, the term "filler material" refers to essentially any textual or graphical content that is not part of the document content. The content of the filler material may be related to the content of the document, but this is not required. The filler material could be a graphical object of arbitrary design, a picture that is related to the document in at least in a general way, textual material such as famous quotations, proverbs or facts, or an advertisement.

[0089] The filler material may be selected from a set of filler materials. The selection may be arbitrary or random, or it may be made on the basis of some criterion such as the size or aspect ratio of the material, or one or more recipient preferences. For example, an individual may be allowed to indicate a preference for graphical filler material as opposed to textual filler material. Each filler material in the set of filler materials may also be classified according to one or more categories and selected on the basis of recipient preferences for topics, subtopics, and keywords in a manner similar to the way in which document content is selected.

#### 5. Foreign Language Dictionary

[0090] The growing use of global networks means recipients are more likely to be exposed to documents having textual content written in a language that they cannot easily understand. In one implementation, each recipient is allowed to indicate his or her preferred language and an indication of proficiency with one or more other languages. For example, a recipient could indicate his preferred language is German and he has less than a college level of proficiency with English and less than a high-school level of proficiency with Japanese. An implementation of the present invention could then identify specific words in English- and Japanese-language documents according to the respective proficiency levels, and include in the representation of the document a German-language definition of the identified words. For example, a representation of a portion of an English-language document could be generated to include the following definitions for a recipient indicating less than a college level of proficiency with English:

Initially, the [*docent*: Dozent, Führer, Tourleiter] was irritated by the [*sophistry*: Sophismus] of the man at the rear of the tour group whose [*specious*: trügerisch, verhänglich] questions seemed to have no other purpose but to embarrass her. But her irritation soon gave way to [*trepidity*: Besorgnis] as the man's behavior became increasingly [*truculent*: aufsässig].

[0091] This feature may be implemented by constructing a dictionary table that cross-references corresponding words in each language of interest and includes an indication of proficiency level. For example, words in the table that correspond to the English word "perspicacious" could be given a college-level indication and words in the table that correspond to the English word "abrogate" could be given a high-school-level indication. A newspaper that is generated for a recipient who specifies less than a high-school level of proficiency in English would include dictionary items for both words, whereas a newspaper that is generated for a recipient who specifies less than a college level of proficiency in English would include a dictionary item for "perspicacious" but not a dictionary item for "abrogate."

#### G. Deliver and Present

[0092] Steps 35 and 57 deliver a representation of newspapers according to delivery preferences specified in each recipient's profile. Table III represents a portion of a few recipient profile records stored in profile database 42. In the example shown, the records are stored in order by user id. The example shown in the table represents delivery preferences for six hypothetical individuals. Any similarity with actual individuals is not intended.

[0093] Each profile record includes a "User id" or recipient identifier, a Destination that specifies where information is to be delivered, an Option that indicates a type of activity, and a Schedule, Day, Time and Zone that specifies when the activity is to take place. For ease of discussion, the times indicated by the Schedule, Day, Time and Zone information are referred to as the "Activity Times" in the examples discussed below. In the examples shown in Table III, each Destination is a hypothetical e-mail address.

[0094] An Option entry equal to "Doc" indicates the recipient has requested delivery of a document conveying a representation of a newspaper to the specified Destination at the specified Activity Times. This Option may be carried out by new server 5 using a method such as method 30 discussed above.

[0095] An Option entry equal to "List" indicates the recipient has requested delivery of a list of suggested articles to the specified Destination at the specified Activity Times. This Option may be carried out by new server 5 using a method such as method 50 discussed above. Preferably, method 50 generates and delivers the newspaper document immediately after receiving the selection of articles made in step 54.

[0096] An Option entry equal to "Auto" indicates the recipient intends to have his or her computer system 7-9 initiate an automatic request for a newspaper. This feature is discussed below.

[0097] Referring to the record for the individual having the User id "Alice," the profile record specifies delivery of a newspaper document for each weekday Monday through Friday at 5:00 pm local time. The Zone entry of -8 indicates the time zone for this individual is eight hours behind Coordinated Universal Time (UTC) or Greenwich Mean Time (GMT). The individual having the User id "Bartok" has requested delivery of a list of suggested articles for each Monday at 6:30 am local time in a time zone that is five hours behind UTC. Referring to the profile record for "Diyang," the delivery of a list is requested for each weekend Saturday and Sunday at 3:30 pm local time in the time zone that is seven hours ahead of UTC.

Table III

User id	Destination	Option	Schedule	Day	Time	Zone
Alice	ahk@e3r4.com	Doc	weekdays		5:00 pm	-8
Bartok	ebh@eee.com	List	weekly	Mon.	6:30 am	-5
Chandra	1639@kfue.net	Auto	daily		9:00 am	+0
Diyang	diyang@srr.com	List	weekend		3:30 pm	+7
Ebony	cre@qky.com	Doc	weekly	Wed.	10:30 am	+1
Jin	abc@xyz.com	Doc	daily		9:00 pm	+9

[0098] This example assumes an individual may request only one newspaper for a particular User id. In implementations that permit an individual to request more than one newspaper, some provision is made to store information for each newspaper. This may be done in a variety of ways such as, for example, having a field for a "Newspaper id" and storing a record for each newspaper.

[0099] In preferred implementations, delivery is made according to delivery control information that is derived from the delivery preferences stored in profile database 42. Table IV illustrates one arrangement of delivery control information that may be derived from recipient profile delivery preferences. In this example, the delivery control information is arranged in order according to the specified Activity Time expressed in absolute or UTC time. This absolute time may be derived by subtracting the Zone offset from the specified Time, as shown in Table III. For example, the absolute delivery time for "Ebony" may be derived by subtracting the Zone offset (1 hour) from the specified Time (10:30 am), which yields 0930 hours.

Table IV

UTC	Schedule	Day	User id	Destination	Option
0830	weekend		Diyang	diyang@srr.com	List
0900	daily		Chandra	1639@kfue.net	Auto
0930	weekly	Wed.	Ebony	cre@qky.com	Doc
1130	weekly	Mon.	Bartok	ebh@eee.com	List
1200	daily		Jin	abc@xyz.com	Doc
2500	weekdays		Alice	ahk@e3r4.com	Doc

[0100] In this particular implementation, the absolute delivery time is allowed to be less than zero and to exceed 2400 hours to account for differences in delivery day. For example, the absolute delivery time for "Alice" is shown to be 2500 hours, which represents 0100 hours the next day. Delivery for Alice is requested for 5:00 pm in time zone -8 on Monday through Friday. This is equivalent to delivery at 0100 hours UTC on Tuesday through Saturday, which may be expressed as 2500 hours UTC for Monday through Friday. This particular scheme simplifies the task of determining the correct day of delivery.

[0101] By arranging the delivery control information in order by absolute delivery time, news server 5 may more easily carry out search, formatting and delivery steps discussed above according to recipient specified delivery schedules. If the recipient has requested delivery of a newspaper document or a list, news server 5 may deliver the document or the list to the intended recipient in essentially any manner such as conventional mail or e-mail; however, delivery by e-mail is generally preferred. Alternatively, the newspaper document or list may be stored and made available for viewing or downloading in response to a request from the recipient.

#### H. Other Features

[0102] The various features discussed above may be used in a wide variety of combinations. A few additional features are discussed here that may be used in combination with the features discussed above.

[0103] According to one feature, an application executing in client computer system 7-9 receives a newspaper representation from news server 5 and automatically prints the representation on printer device 27. This application may be implemented in a variety of ways including as a component of client "browser" software that monitors and detects the arrival of downloaded information conveying the newspaper representation.

[0104] According to another feature, news server 5 generates a newspaper representation in a form that is intended for presentation by printer device 27 but, preferably, is not intended for presentation by display device 26. This may be accomplished in a variety of ways. Two are mentioned here.

[0105] One way, mentioned above, generates the presentation in a native printer format such as the Printer Control Language (PCL). The format may be printed easily using a printer device 27 that is compatible with the particular native format. If this way is used, preferred implementations include in the individual profile some designation of printer type so that the representation can be generated in the proper format.

[0106] Another way generates the presentation in an encrypted form that cannot be easily deciphered by conventional viewing programs for presentation on display device 26, but can be deciphered by components of printing systems such as printer driver software.

[0107] These implementations may generate representations of newspapers in which the bulk of document content may only be printed but include summaries or titles of articles that can be presented on display device 26. This arrangement would allow a recipient to review the summaries or titles before deciding whether to print the representation.

#### I. Automatic Option

[0108] Methods 30 and 50 discussed above are two examples of implementations that news server 5 can perform to "push" a newspaper document to a recipient. In the implementation of news server 5 discussed above, a profile Option of "Auto" indicates a recipient intends to "pull" a newspaper document to his or her computer system 7-9. This may be accomplished by retrieval software executing on the recipient's computer system that initiates communication with news server 5 to request a newspaper document. In one implementation, an indication of the desired Activity Times are stored as Schedule, Day, Time and Zone profile information on news server 5, and an indication of the desired Activity Times are stored on the recipient's computer system. News server 5 generates and stores a representation of a newspaper so that is available before the Activity Times indicated in the profile information, and the retrieval software executing on the recipient's computer system 7-9 requests delivery of the representation shortly after the Activity Times. In an alternative implementation, news server 5 both generates and delivers a newspaper document in response to a request made by the retrieval software.

[0109] In one implementation, the retrieval software executing on recipient computer system 7-9 receives the document conveying the representation of a newspaper from -news-server-5-and-stores the document in storage device 25. In another implementation, the retrieval software also automatically prints the representation on printer device 27.

#### J. Revise Preferences

[0110] Method 30 may include an additional step that receives indications of recipient activity with respect to the formatted newspaper and revise profile information to reflect changes in a recipient's preferred topics, subtopics and keywords. In one implementation, an application that operates in recipient computer system 7-9 sends a message to network server 5 indicating which articles the recipient views or prints by display device 26 or printer device 27, re-

spectively. These indications may be considered a measure of recipient interest and may be used to modify the relative priority of topics and subtopics in the recipient's profile. The step may also add and remove topics and subtopics.

[0111] In yet another implementation that provides links in a newspaper to document content that was omitted, news server 5 may revise recipient preferences in response to reports of the recipient using the links to access the omitted content.

### Claims

1. A method for providing a personalized presentation of news and information to a recipient comprising steps that perform the acts of:

obtaining preferences of the recipient, wherein the preferences include an indication of one or more preferred categories and a preferred presentation layout;  
identifying a plurality of documents each having content deemed to satisfy one or more criteria with respect to the one or more preferred categories;  
generating a list of entries in which each entry corresponds to a respective document in the plurality of documents and delivering an indication of the list to the recipient;  
receiving from the recipient an indication of selected entries in the list of entries selected by the recipient and identifying one or more selected documents corresponding to the selected entries;  
obtaining content information that represent at least part of the content of each selected document; and  
generating a representation of articles including the content information such that a presentation of the representation conforms to the preferred presentation layout.

2. A method according to claim 1 wherein the indication of the list is a document conveying the list of entries in which each entry includes a description and a link to a respective one of the plurality of documents.

3. A method according to claim 1 wherein the indication of the list is a link to a document conveying the list of entries in which each entry describes a respective one of the plurality of documents.

4. A method according to claim 2 that further comprises receiving the generated representation at the destination and automatically printing the presentation of the representation.

5. A method according to claim 1 that comprises:

obtaining measures of satisfaction for the plurality of documents indicating how well the content of each respective document is deemed to satisfy the one or more criteria; and  
arranging the list of entries in order according to the measures of satisfaction of the corresponding documents.

6. A method according to claim 5 wherein the preferences include an indication of one or more key words, and wherein the measures of satisfaction vary according to a frequency of occurrence of the one or more key words within the content of each respective document.

7. A method according to claim 5 wherein the preferences include an indication of one or more key words, and wherein the measures of satisfaction indicate vary according to a location frequency of occurrence of the one or more key words within the content of each respective document.

8. A method according to claim 1 wherein the preferred presentation layout corresponds to a layout selected by the recipient from a plurality of layouts.

9. A method according to claim 1 wherein the preferred presentation layout prescribes an area in which an advertisement is to be presented, and wherein the method comprises

obtaining an advertising category preference of the recipient;  
selecting advertising material from a set of advertising materials according to the advertising category preference; and  
generating the representation such that the presentation includes in the prescribed area the selected advertising material.

10. A system for providing a personalized presentation of news and information to a recipient comprising one or more computers connected by a network, wherein the one or more computers include one or more processors, random access memory in communication with the one or more processors, one or more storage devices in communication with the one or more processors, and interface circuits coupled to the network and in communication with the one or more processors, wherein the storage devices store one or more programs of instructions that, when executed by the one or more processors, cause the one or more computers and the network to perform a method that comprises:

obtaining preferences of the recipient, wherein the preferences include an indication of one or more preferred categories and a preferred presentation layout;  
 identifying a plurality of documents each having content deemed to satisfy one or more criteria with respect to the one or more preferred categories;  
 generating a list of entries in which each entry corresponds to a respective document in the plurality of documents and delivering an indication of the list to the recipient;  
 receiving from the recipient an indication of selected entries in the list of entries selected by the recipient and identifying one or more selected documents corresponding to the selected entries;  
 obtaining content information that represent at least part of the content of each selected document; and  
 generating a representation of articles including the content information such that a presentation of the representation conforms to the preferred presentation layout.

11. A system according to claim 10 wherein the indication of the list is a document conveying the list of entries in which each entry includes a description and a link to a respective one of the plurality of documents.

12. A system according to claim 10 wherein the indication of the list is a link to a document conveying the list of entries in which each entry describes a respective one of the plurality of documents.

13. A system according to claim 11 wherein the method further comprises receiving the generated representation at the destination and automatically printing the presentation of the representation.

14. A system according to claim 10 wherein the method comprises:

obtaining measures of satisfaction for the plurality of documents indicating how well the content of each respective document is deemed to satisfy the one or more criteria; and  
 arranging the list of entries in order according to the measures of satisfaction of the corresponding documents.

15. A system according to claim 14 wherein the preferences include an indication of one or more key words, and wherein the measures of satisfaction vary according to a frequency of occurrence of the one or more key words within the content of each respective document.

16. A system according to claim 14 wherein the preferences include an indication of one or more key words, and wherein the measures of satisfaction indicate vary according to a location frequency of occurrence of the one or more key words within the content of each respective document.

17. A system according to claim 10 wherein the preferred presentation layout corresponds to a layout selected by the recipient from a plurality of layouts.

18. A system according to claim 10 wherein the preferred presentation layout prescribes an area in which an advertisement is to be presented, and wherein the method comprises

obtaining an advertising category preference of the recipient;  
 selecting advertising material from a set of advertising materials according to the advertising category preference; and  
 generating the representation such that the presentation includes in the prescribed area the selected advertising material.

19. A medium readable by a device and conveying one or more programs of instructions for execution by the device to perform a method for providing a personalized presentation of news and information to a recipient, wherein the method comprises:

obtaining preferences of the recipient, wherein the preferences include an indication of one or more preferred categories and a preferred presentation layout;  
identifying a plurality of documents each having content deemed to satisfy one or more criteria with respect to the one or more preferred categories;  
5 generating a list of entries in which each entry corresponds to a respective document in the plurality of documents and delivering an indication of the list to the recipient;  
receiving from the recipient an indication of selected entries in the list of entries selected by the recipient and identifying one or more selected documents corresponding to the selected entries;  
10 obtaining content information that represent at least part of the content of each selected document; and  
generating a representation of articles including the content information such that a presentation of the representation conforms to the preferred presentation layout.

20. A medium according to claim 19 wherein the indication of the list is a document conveying the list of entries in which each entry includes a description and a link to a respective one of the plurality of documents.

21. A medium according to claim 19 wherein the indication of the list is a link to a document conveying the list of entries in which each entry describes a respective one of the plurality of documents.

22. A medium according to claim 20 wherein the method further comprises receiving the generated representation at the destination and automatically printing the presentation of the representation.

23. A medium according to claim 19 wherein the method comprises:

obtaining measures of satisfaction for the plurality of documents indicating how well the content of each respective document is deemed to satisfy the one or more criteria; and  
arranging the list of entries in order according to the measures of satisfaction of the corresponding documents.

24. A medium according to claim 23 wherein the preferences include an indication of one or more key words, and wherein the measures of satisfaction vary according to a frequency of occurrence of the one or more key words within the content of each respective document.

25. A medium according to claim 23 wherein the preferences include an indication of one or more key words, and wherein the measures of satisfaction indicate vary according to a location frequency of occurrence of the one or more key words within the content of each respective document.

26. A medium according to claim 19 wherein the preferred presentation layout corresponds to a layout selected by the recipient from a plurality of layouts.

27. A medium according to claim 19 wherein the preferred presentation layout prescribes an area in which an advertisement is to be presented, and wherein the method comprises

obtaining an advertising category preference of the recipient;  
selecting advertising material from a set of advertising materials according to the advertising category preference; and  
45 generating the representation such that the presentation includes in the prescribed area the selected advertising material.

28. A method for conducting business that comprises the steps of:

obtaining preferences of a recipient, wherein the preferences include an indication of one or more preferred categories, a preferred presentation layout, and a preferred advertising category;  
obtaining content information having content in at least one of the preferred categories; and  
providing to the recipient a printable representation of a newspaper having articles with the content information and having an advertisement with content in the preferred advertising category, wherein a printing of the representation conforms to the preferred presentation layout.

29. A method according to claim 28 that comprises charging a fee to a party in exchange for including the advertisement in the printable representation.



30. A method according to claim 28 that comprises:

generating a list of suggested articles having content in at least one of the preferred categories; and  
receiving from the recipient a selection of one or more articles from the list of suggested articles;

5

wherein the content information is obtained from the articles selected by the recipient.

31. A method for providing a personalized presentation of news and information to a recipient comprising steps that perform the acts of:

10

obtaining preferences of the recipient, wherein the preferences include an indication of one or more preferred categories and a preferred presentation layout;

identifying a plurality of documents each having content deemed to satisfy one or more criteria with respect to the one or more preferred categories;

15

obtaining content information that represent at least part of the content of the plurality of documents; and  
generating a representation of articles including the content information such that a presentation of the representation conforms to the preferred presentation layout.

32. A method according to claim 31 wherein the preferences include an indication of a destination and the method comprises sending the representation of articles by electronic transmission to the destination.

20

33. A method according to claim 32 wherein the representation is generated in a form that is intended for presentation only by a device in a specified set of printing devices.

25

34. A method according to claim 32 that further comprises receiving the generated representation at the destination and automatically printing the presentation of the representation.

35. A method according to claim 32 wherein the preferences include an indication of preferred delivery schedule and the method sends the representation of articles according to the preferred delivery schedule.

30

36. A method according to claim 35 that comprises constructing delivery control information from indications in the preferences of a plurality of recipients and ordering the delivery control information according to the preferred delivery schedules, wherein representations of articles are generated and sent according to content and order of the delivery control information.

35

37. A method according to claim 31 that identifies one or more documents having graphical content that are deemed to satisfy one or more criteria by examining caption information for the graphical content.

38. A method according to claim 31 that comprises associating a document having graphical content with another document having textual content.

40

39. A method according to claim 31 that generates the representation of articles for presentation using a spatial resolution indicated by one or more preferences of the recipient.

45

40. A method according to claim 31 that comprises:

obtaining measures of satisfaction for the plurality of documents indicating how well the content of each respective document is deemed to satisfy the one or more criteria; and

generating the representation of articles such that articles in the presentation are arranged according to the measures of satisfaction.

50

41. A method according to claim 40 wherein the preferences include an indication of one or more subcategories for at least one of the preferred categories, and wherein the measures of satisfaction indicate how well the content of each respective document is deemed to satisfy one or more criteria with respect to the one or more subcategories.

55

42. A method according to claim 40 wherein the preferences include an indication of one or more key words, and wherein the measures of satisfaction vary according to a frequency of occurrence of the one or more key words

within the content of each respective document.

- 5 43. A method according to claim 40 wherein the preferences include an indication of one or more key words, and wherein the measures of satisfaction indicate vary according to a location frequency of occurrence of the one or more key words within the content of each respective document.
44. A method according to claim 40 that generates the representation of articles such that those articles corresponding to documents having relatively low measures of satisfaction are shorter than other articles in the representation.
- 10 45. A method according to claim 44 wherein those articles corresponding to documents having relatively low measures of satisfaction have a body of text obtained from the first paragraph of the content of the corresponding document.
46. A method according to claim 31 wherein the preferred presentation layout corresponds to a layout selected by the recipient from a plurality of layouts.
- 15 47. A method according to claim 31 wherein the preferences include an indication of a relative amount text and graphic content to be included in the representation of articles.
48. A method according to claim 31 wherein the preferences include an indication of preferred type font or size for the presentation of the representation.
- 20 49. A method according to claim 31 wherein the preferences include an indication of a number of pages in the presentation for those articles having content deemed to satisfy a respective preferred category.
- 25 50. A method according to claim 31 wherein the content information for a respective document includes a graphical object having a size and an aspect ratio, and the step that generates the representation of articles modifies the content information to change the size but preserve the aspect ratio of the graphical object.
- 30 51. A method according to claim 50 wherein the presentation of the representation of an article comprises text arranged in a plurality of columns and the size of the graphical object is changed to span all but one of the plurality of columns.
52. A method according to claim 50 wherein the presentation of the representation of an article comprises text arranged in one or more columns and the size of the graphical object is changed to span one column.
- 35 53. A method according to claim 31 wherein the preferred presentation layout prescribes a section of a specified page in which one article of text is to be presented, and the step that generates the representation of articles changes text font size or line spacing to adjust the article presentation to fit within the section of the specified page.
- 40 54. A method according to claim 31 wherein the preferred presentation layout prescribes a section of a specified page in which one article of text is to be presented, and the step that generates the representation of articles divides the content information of an article into a first part and a second part that immediately follows the first part such that a presentation of the first part fits within the section of the specified page and a presentation of at least a portion of the second part is included on a subsequent page, wherein the presentation of the first part includes a reference to the subsequent page on which the second portion is to be presented.
- 45 55. A method according to claim 31 wherein the preferred presentation layout prescribes a section of a specified page in which one article of text is to be presented, and the step that generates the representation of articles includes in the representation only that part of the content information of an article whose presentation fits within the section of the specified page, wherein the presentation of the part of the content information includes an indication that some content information is omitted from the presentation.
- 50 56. A method according to claim 55 wherein the indication of omitted content comprises an identification of or access information to a document containing the omitted content.
- 55 57. A method according to claim 31 wherein the preferred presentation layout prescribes an area in which one article of text is to be presented, and wherein the method comprises

selecting filler material from a set of of filler materials such that a presentation of the selected filter material

with a respective article of text substantially fills the prescribed area; and generating the representation such that the presentation includes in the specified area the content information of the respective article of text and the selected filler material.

- 5 58. A method according to claim 57 wherein the filler material is selected according to its size or its aspect ratio.
59. A method according to claim 57 wherein the filler material is selected according to content of the filler material.
- 10 60. A method according to claim 59 wherein the filler material is selected also according to the preferences of the recipient.
61. A method according to claim 31 wherein the content information for one article is in a first language and the step that generates the representation of articles also generates a dictionary in a second language for words selected from the content information.
- 15 62. A method according to claim 61 wherein the preferences include an indication of dictionary-word choice, and wherein words are selected for the dictionary according to the indication of dictionary-word choice.
- 20 63. A method according to claim 31 that comprises:  
receiving from the recipient an indication of preferred articles in the representation of articles; and  
revising in response thereto the one or more preferred categories to reflect changes in the preferences of the recipient.
- 25 64. A method according to claim 31 that comprises:  
receiving an indication that the representation has been printed; and  
revising in response thereto the one or more preferred categories to reflect changes in the preferences of the recipient.
- 30 65. A system for providing a personalized presentation of news and information to a recipient comprising one or more computers connected by a network, wherein the one or more computers include one or more processors, random access memory in communication with the one or more processors, one or more storage devices in communication with the one or more processors, and interface circuits coupled to the network and in communication with the one or more processors, wherein the storage devices store one or more programs of instructions that, when executed by the one or more processors, cause the one or more computers and the network to perform a method that comprises:  
40 obtaining preferences of the recipient, wherein the preferences include an indication of one or more preferred categories and a preferred presentation layout;  
identifying a plurality of documents each having content deemed to satisfy one or more criteria with respect to the one or more preferred categories;  
obtaining content information that represent at least part of the content of the plurality of documents; and  
45 generating a representation of articles including the content information such that a presentation of the representation conforms to the preferred presentation layout.
66. A system according to claim 65 wherein the preferences include an indication of a destination and the method comprises sending the representation of articles by electronic transmission to the destination.
- 50 67. A system according to claim 66 wherein the representation is generated in a form that is intended for presentation only by a device in a specified set of printing devices.
68. A system according to claim 66 that further comprises receiving the generated representation at the destination and automatically printing the presentation of the representation.
- 55 69. A system according to claim 66 wherein the preferences include an indication of preferred delivery schedule and the method sends the representation of articles according to the preferred delivery schedule.

- 5
70. A system according to claim 69 that comprises constructing delivery control information from indications in the preferences of a plurality of recipients and ordering the delivery control information according to the preferred delivery schedules, wherein representations of articles are generated and sent according to content and order of the delivery control information.
71. A system according to claim 65 that identifies one or more documents having graphical content that are deemed to satisfy one or more criteria by examining caption information for the graphical content.
- 10
72. A system according to claim 65 that comprises associating a document having graphical content with another document having textual content.
73. A system according to claim 65 that generates the representation of articles for presentation using a spatial resolution indicated by one or more preferences of the recipient.
- 15
74. A system according to claim 65 that comprises:
- obtaining measures of satisfaction for the plurality of documents indicating how well the content of each respective document is deemed to satisfy the one or more criteria; and  
generating the representation of articles such that articles in the presentation are arranged according to the  
20 measures of satisfaction.
75. A system according to claim 74 wherein the preferences include an indication of one or more subcategories for at least one of the preferred categories, and wherein the measures of satisfaction indicate how well the content of each respective document is deemed to satisfy one or more criteria with respect to the one or more subcategories.
- 25
76. A system according to claim 74 wherein the preferences include an indication of one or more key words, and wherein the measures of satisfaction vary according to a frequency of occurrence of the one or more key words within the content of each respective document.
- 30
77. A system according to claim 74 wherein the preferences include an indication of one or more key words, and wherein the measures of satisfaction indicate vary according to a location frequency of occurrence of the one or more key words within the content of each respective document.
- 35
78. A system according to claim 74 that generates the representation of articles such that those articles corresponding to documents having relatively low measures of satisfaction are shorter than other articles in the representation.
79. A system according to claim 78 wherein those articles corresponding to documents having relatively low measures of satisfaction have a body of text obtained from the first paragraph of the content of the corresponding document.
- 40
80. A system according to claim 65 wherein the preferred presentation layout corresponds to a layout selected by the recipient from a plurality of layouts.
- 45
81. A system according to claim 65 wherein the preferences include an indication of a relative amount text and graphic content to be included in the representation of articles.
82. A system according to claim 65 wherein the preferences include an indication of preferred type font or size for the presentation of the representation.
- 50
83. A system according to claim 65 wherein the preferences include an indication of a number of pages in the presentation for those articles having content deemed to satisfy a respective preferred category.
84. A system according to claim 65 wherein the content information for a respective document includes a graphical object having a size and an aspect ratio, and the step that generates the representation of articles modifies the content information to change the size but preserve the aspect ratio of the graphical object.
- 55
85. A system according to claim 84 wherein the presentation of the representation of an article comprises text arranged in a plurality of columns and the size of the graphical object is changed to span all but one of the plurality of columns.

86. A system according to claim 84 wherein the presentation of the representation of an article comprises text arranged in one or more columns and the size of the graphical object is changed to span one column.

5 87. A system according to claim 65 wherein the preferred presentation layout prescribes a section of a specified page in which one article of text is to be presented, and the step that generates the representation of articles changes text font size or line spacing to adjust the article presentation to fit within the section of the specified page.

10 88. A system according to claim 65 wherein the preferred presentation layout prescribes a section of a specified page in which one article of text is to be presented, and the step that generates the representation of articles divides the content information of an article into a first part and a second part that immediately follows the first part such that a presentation of the first part fits within the section of the specified page and a presentation of at least a portion of the second part is included on a subsequent page, wherein the presentation of the first part includes a reference to the subsequent page on which the second portion is to be presented.

15 89. A system according to claim 65 wherein the preferred presentation layout prescribes a section of a specified page in which one article of text is to be presented, and the step that generates the representation of articles includes in the representation only that part of the content information of an article whose presentation fits within the section of the specified page, wherein the presentation of the part of the content information includes an indication that some content information is omitted from the presentation.

20 90. A system according to claim 89 wherein the indication of omitted content comprises an identification of or access information to a document containing the omitted content.

25 91. A system according to claim 65 wherein the preferred presentation layout prescribes an area in which one article of text is to be presented, and wherein the method comprises

30 selecting filler material from a set of filler materials such that a presentation of the selected filler material with a respective article of text substantially fills the prescribed area; and generating the representation such that the presentation includes in the specified area the content information of the respective article of text and the selected filler material.

92. A system according to claim 91 wherein the filler material is selected according to its size or its aspect ratio.

35 93. A system according to claim 91 wherein the filler material is selected according to content of the filler material.

94. A system according to claim 93 wherein the filler material is selected also according to the preferences of the recipient.

40 95. A system according to claim 65 wherein the content information for one article is in a first language and the step that generates the representation of articles also generates a dictionary in a second language for words selected from the content information.

45 96. A system according to claim 95 wherein the preferences include an indication of dictionary-word choice, and wherein words are selected for the dictionary according to the indication of dictionary-word choice.

97. A system according to claim 65 that comprises:

50 receiving from the recipient an indication of preferred articles in the representation of articles; and revising in response thereto the one or more preferred categories to reflect changes in the preferences of the recipient.

98. A system according to claim 65 that comprises:

55 receiving an indication that the representation has been printed; and revising in response thereto the one or more preferred categories to reflect changes in the preferences of the recipient.

99. A medium readable by a device and conveying one or more programs of instructions for execution by the device

to perform a method for providing a personalized presentation of news and information to a recipient, wherein the method comprises:

5           obtaining preferences of the recipient, wherein the preferences include an indication of one or more preferred categories and a preferred presentation layout;  
          identifying a plurality of documents each having content deemed to satisfy one or more criteria with respect to the one or more preferred categories;  
          obtaining content information that represent at least part of the content of the plurality of documents; and  
10           generating a representation of articles including the content information such that a presentation of the representation conforms to the preferred presentation layout.

100.A medium according to claim 99 wherein the preferences include an indication of a destination and the method comprises sending the representation of articles by electronic transmission to the destination.

15 101.A medium according to claim 100 wherein the representation is generated in a form that is intended for presentation only by a device in a specified set of printing devices.

102.A medium according to claim 100 that further comprises receiving the generated representation at the destination and automatically printing the presentation of the representation.

20 103.A medium according to claim 100 wherein the preferences include an indication of preferred delivery schedule and the method sends the representation of articles according to the preferred delivery schedule.

25 104.A medium according to claim 103 that comprises constructing delivery control information from indications in the preferences of a plurality of recipients and ordering the delivery control information according to the preferred delivery schedules, wherein representations of articles are generated and sent according to content and order of the delivery control information.

30 105.A medium according to claim 99 that identifies one or more documents having graphical content that are deemed to satisfy one or more criteria by examining caption information for the graphical content.

106.A medium according to claim 99 that comprises associating a document having graphical content with another document having textual content.

35 107.A medium according to claim 99 that generates the representation of articles for presentation using a spatial resolution indicated by one or more preferences of the recipient.

108.A medium according to claim 99 that comprises:

40           obtaining measures of satisfaction for the plurality of documents indicating how well the content of each respective document is deemed to satisfy the one or more criteria; and  
          generating the representation of articles such that articles in the presentation are arranged according to the measures of satisfaction.

45 109.A medium according to claim 108 wherein the preferences include an indication of one or more subcategories for at least one of the preferred categories, and wherein the measures of satisfaction indicate how well the content of each respective document is deemed to satisfy one or more criteria with respect to the one or more subcategories.

50 110.A medium according to claim 108 wherein the preferences include an indication of one or more key words, and wherein the measures of satisfaction vary according to a frequency of occurrence of the one or more key words within the content of each respective document.

55 111.A medium according to claim 108 wherein the preferences include an indication of one or more key words, and wherein the measures of satisfaction indicate vary according to a location frequency of occurrence of the one or more key words within the content of each respective document.

112.A medium according to claim 108 that generates the representation of articles such that those articles correspond-

ing to documents having relatively low measures of satisfaction are shorter than other articles in the representation.

- 5 113.A medium according to claim 112 wherein those articles corresponding to documents having relatively low measures of satisfaction have a body of text obtained from the first paragraph of the content of the corresponding document.
- 114.A medium according to claim 99 wherein the preferred presentation layout corresponds to a layout selected by the recipient from a plurality of layouts.
- 10 115.A medium according to claim 99 wherein the preferences include an indication of a relative amount text and graphic content to be included in the representation of articles.
- 116.A medium according to claim 99 wherein the preferences include an indication of preferred type font or size for the presentation of the representation.
- 15 117.A medium according to claim 99 wherein the preferences include an indication of a number of pages in the presentation for those articles having content deemed to satisfy a respective preferred category.
- 20 118.A medium according to claim 99 wherein the content information for a respective document includes a graphical object having a size and an aspect ratio, and the step that generates the representation of articles modifies the content information to change the size but preserve the aspect ratio of the graphical object.
- 25 119.A medium according to claim 118 wherein the presentation of the representation of an article comprises text arranged in a plurality of columns and the size of the graphical object is changed to span all but one of the plurality of columns.
- 30 120.A medium according to claim 118 wherein the presentation of the representation of an article comprises text arranged in one or more columns and the size of the graphical object is changed to span one column.
- 35 121.A medium according to claim 99 wherein the preferred presentation layout prescribes a section of a specified page in which one article of text is to be presented, and the step that generates the representation of articles changes text font size or line spacing to adjust the article presentation to fit within the section of the specified page.
- 40 122.A medium according to claim 99 wherein the preferred presentation layout prescribes a section of a specified page in which one article of text is to be presented, and the step that generates the representation of articles divides the content information of an article into a first part and a second part that immediately follows the first part such that a presentation of the first part fits within the section of the specified page and a presentation of at least a portion of the second part is included on a subsequent page, wherein the presentation of the first part includes a reference to the subsequent page on which the second portion is to be presented.
- 45 123.A medium according to claim 99 wherein the preferred presentation layout prescribes a section of a specified page in which one article of text is to be presented, and the step that generates the representation of articles includes in the representation only that part of the content information of an article whose presentation fits within the section of the specified page, wherein the presentation of the part of the content information includes an indication that some content information is omitted from the presentation.
- 124.A medium according to claim 123 wherein the indication of omitted content comprises an identification of or access information to a document containing the omitted content.
- 50 125.A medium according to claim 99 wherein the preferred presentation layout prescribes an area in which one article of text is to be presented, and wherein the method comprises
- 55 selecting filler material from a set of of filler materials such that a presentation of the selected filter material with a respective article of text substantially fills the prescribed area; and  
generating the representation such that the presentation includes in the specified area the content information of the respective article of text and the selected filler material.
- 126.A medium according to claim 125 wherein the filler material is selected according to its size or its aspect ratio.

127.A medium according to claim 125 wherein the filler material is selected according to content of the filler material.

128.A medium according to claim 127 wherein the filler material is selected also according to the preferences of the recipient.

5

129.A medium according to claim 99 wherein the content information for one article is in a first language and the step that generates the representation of articles also generates a dictionary in a second language for words selected from the content information.

10 130.A medium according to claim 129 wherein the preferences include an indication of dictionary-word choice, and wherein words are selected for the dictionary according to the indication of dictionary-word choice.

131.A medium according to claim 99 that comprises:

15 receiving from the recipient an indication of preferred articles in the representation of articles; and revising in response thereto the one or more preferred categories to reflect changes in the preferences of the recipient.

132.A medium according to claim 99 that comprises:

20 receiving an indication that the representation has been printed; and revising in response thereto the one or more preferred categories to reflect changes in the preferences of the recipient.

25 133.A method for conducting business that comprises the steps of:

obtaining preferences of a recipient, wherein the preferences include an indication of one or more preferred categories;  
30 obtaining information having content in at least one of the preferred categories;  
providing to the recipient a printable representation of the information that, when printed, includes a coupon deemed to be of value to the recipient, thereby encouraging the recipient to print the representation.

134.A method according to claim 133 wherein the coupon is for obtaining a discount or rebate for printing supplies.

35 135.A method according to claim 134 that further comprises receiving the coupon and providing a rebate for the printing supplies.

136.A method according to claim 134 that further comprises receiving the coupon and selling the printing supplies at a discount.

40

137.A method according to claim 134 wherein the printing supplies are any from the set of supplies including paper, ink, and toner.

45 138.A method according to claim 133 wherein the printable representation is in the form of a newspaper having content and layout that conform to the preferences of the recipient.

139.A method according to claim 133 wherein the printable representation, when printed, includes one or more advertisements.

50 140.A method according to claim 139 that comprises controlling content of the one or more advertisements according to the preferences of the recipient.

141.A method for conducting business that comprises the steps of:

55 obtaining preferences of a recipient, wherein the preferences include an indication of one or more preferred categories;  
obtaining information having content in at least one of the preferred categories;  
providing to the recipient a printable representation of the information; and



receiving an indication of recipient activity with respect to the printable representation.

5 142. A method according to claim 141 wherein the indication of recipient activity indicates whether the printable representation was printed.

10 143. A method according to claim 142 wherein the indication of recipient activity indicates which portion of the printable representation was printed.

15 144. A method according to claim 141 that comprises modifying the preferences according to the indication of recipient activity.

20

25

30

35

40

45

50

55

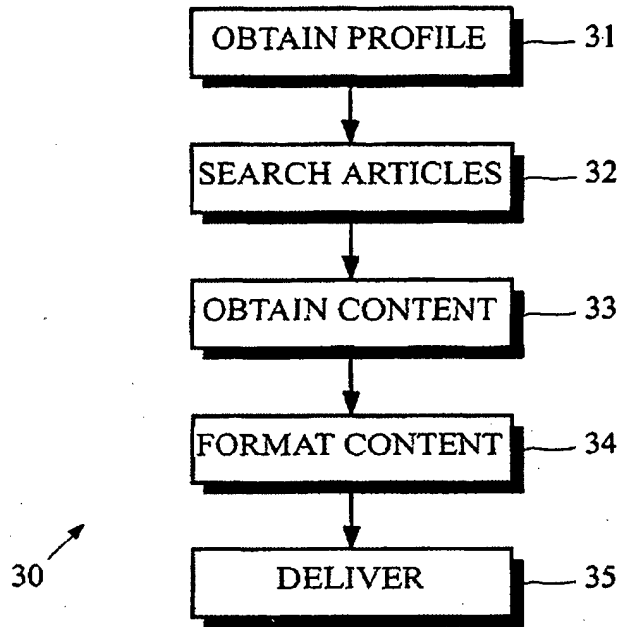

Fig. 1A

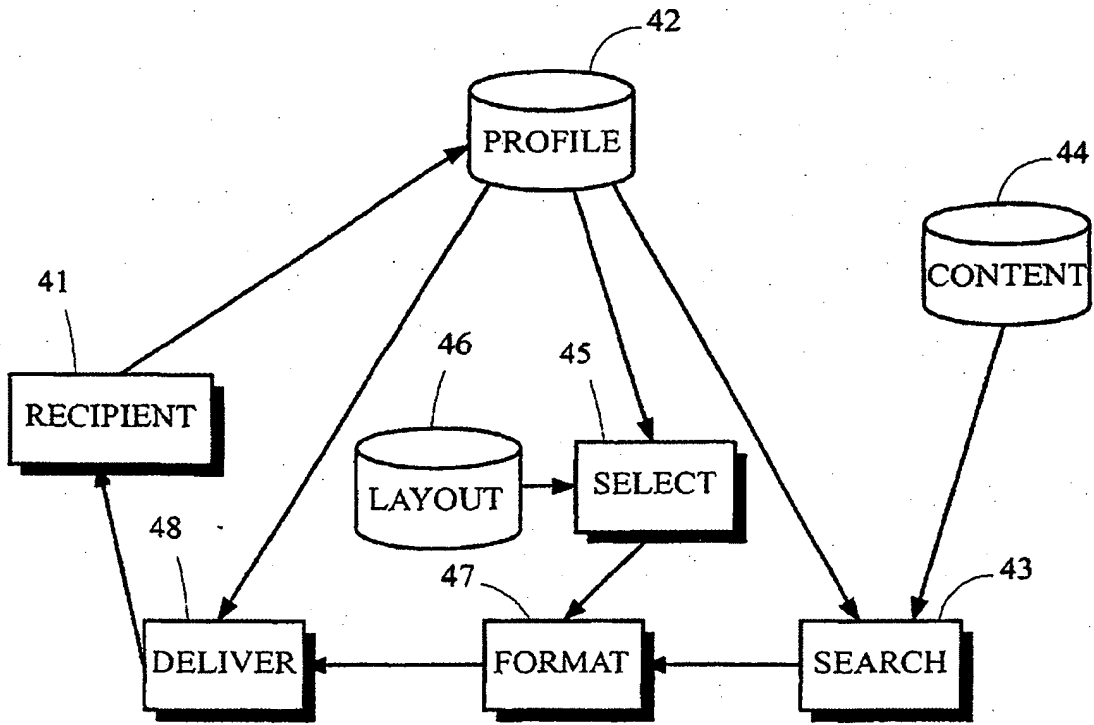

Fig. 1B

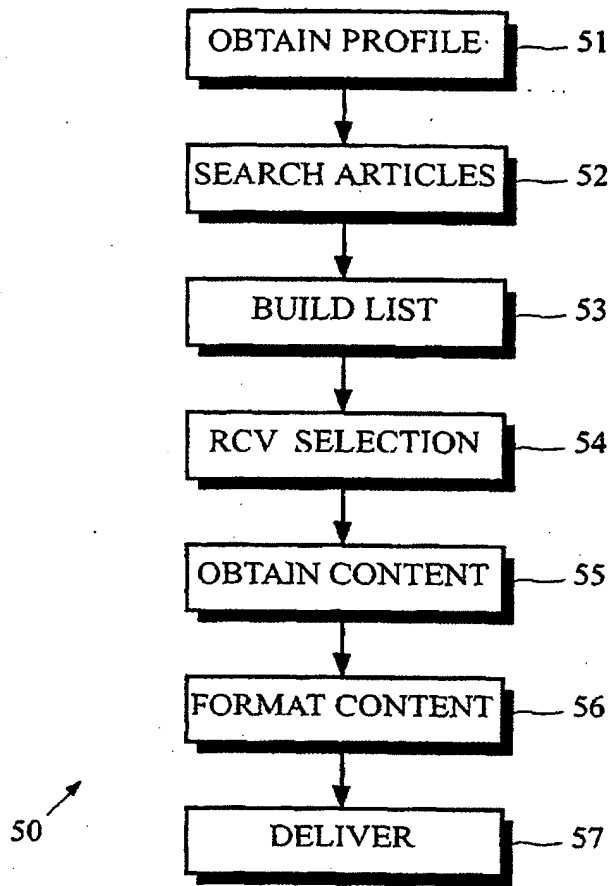

Fig. 2A

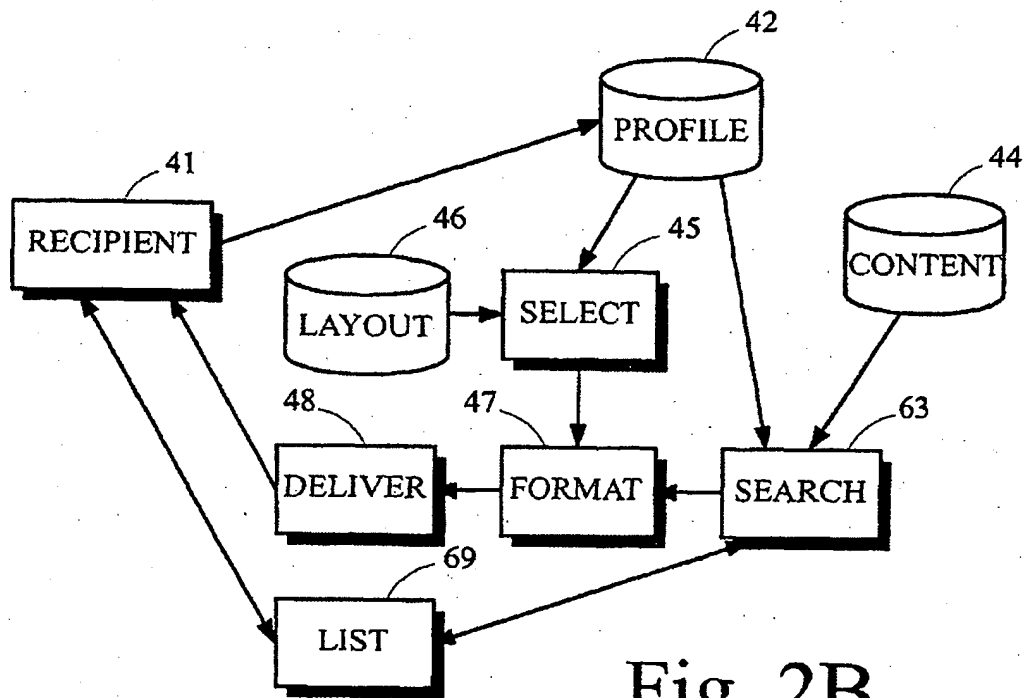

Fig. 2B

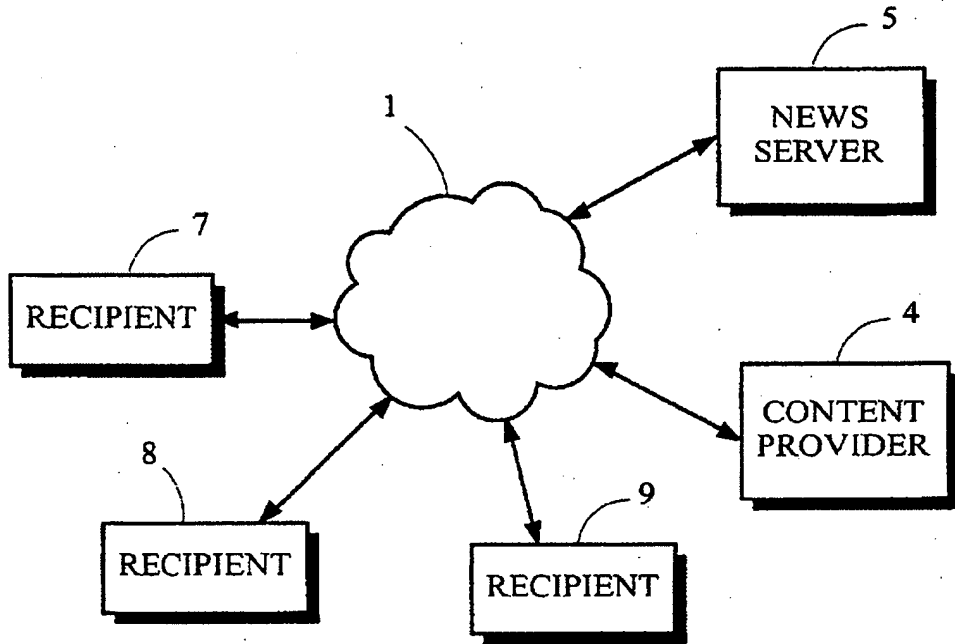

Fig. 3

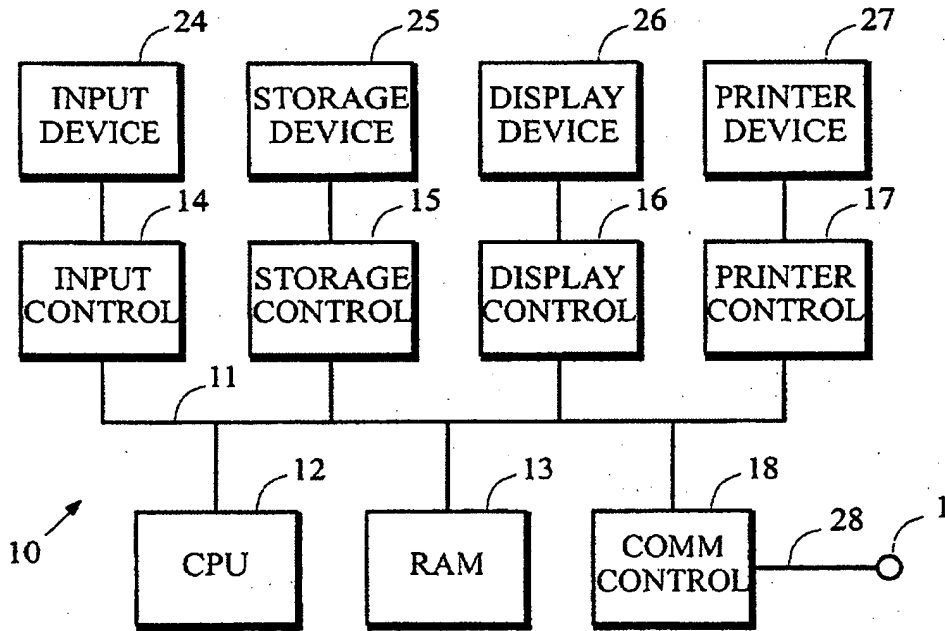

Fig. 4

Print your own customized newspaper

If you are already registered,  
enter your user id here:   
and your password here:

then click "GO" to see current preferences.

If you are not already registered and would like to  
register for a new subscription, click here.

Fig. 5A

Step 1

Select up to six news topics in order of interest.

▼  ▼  ▼

▼  ▼  ▼

Click here to

Fig. 5B

**Step 2**

You may specify subtopics and keywords to refine your selected topics:

<u>You selected these topics:</u>	<u>You may select subtopics ...</u>	<u>and keywords</u>
1. Domestic	Subtopic 1 ▼	<input type="text"/>
2. Sports	Subtopic 2 ▼	<input type="text"/>

Click here to

Fig. 5C

**Step 3**

Select the layout you prefer.

<input type="checkbox"/>	<input checked="" type="checkbox"/>	<input type="checkbox"/>	<input type="checkbox"/>																											
<table border="1" style="border-collapse: collapse; width: 20px; height: 20px;"><tr><td colspan="3">BANNER</td></tr><tr><td style="width: 5px; height: 10px;"></td><td style="width: 10px; height: 10px;"></td><td style="width: 5px; height: 10px;"></td></tr><tr><td style="width: 5px; height: 10px;"></td><td style="width: 10px; height: 10px;"></td><td style="width: 5px; height: 10px;"></td></tr></table>	BANNER									<table border="1" style="border-collapse: collapse; width: 20px; height: 20px;"><tr><td colspan="2">BANNER</td></tr><tr><td style="width: 10px; height: 10px;"></td><td style="width: 10px; height: 10px;"></td></tr><tr><td style="width: 10px; height: 10px;"></td><td style="width: 10px; height: 10px;"></td></tr></table>	BANNER						<table border="1" style="border-collapse: collapse; width: 20px; height: 20px;"><tr><td colspan="2">BANNER</td></tr><tr><td style="width: 10px; height: 10px;"></td><td style="width: 10px; height: 10px;"></td></tr><tr><td style="width: 10px; height: 10px;"></td><td style="width: 10px; height: 10px;"></td></tr></table>	BANNER						<table border="1" style="border-collapse: collapse; width: 20px; height: 20px;"><tr><td colspan="2">BANNER</td></tr><tr><td style="width: 10px; height: 10px;"></td><td style="width: 10px; height: 10px;"></td></tr><tr><td style="width: 10px; height: 10px;"></td><td style="width: 10px; height: 10px;"></td></tr></table>	BANNER					
BANNER																														
BANNER																														
BANNER																														
BANNER																														

Select a font size for the text:  ▼

Click here to

Fig. 5D

**Step 4**

Specify when you wish to receive your newspaper:

- Daily
- Weekly  ▼
- Weekdays (M-F)
- Weekend (Sat, Sun)

Specify  ▼ and  ▼

Click here to

**Fig. 5E**

**Step 5**

Specify where to deliver your newspaper by entering your e-mail address:

Enter a user id   
and a password

so you can log in and change your subscription whenever you wish.

Click here to

**Fig. 5F**

### Current Preferences

Review your current preferences and change them if you wish:

Topics:            Subtopics:            Key words:  
1. Domestic    Agriculture, Weather    water, rice, ...  
2. Sports        Basketball                NBA, NCAA

Click here to

Layout: 

BANNER	

 with medium font size.

Click here to

Schedule:    Week days (M-F) at 8:30 am PST

Click here to

Delivery:    by e-mail to: abc@xyz.com

Click here to

Account:

Your user id is: Jin  
Your password is: \*\*\*\*\*

Click here to

Click here to  or

Fig. 5G



## Step 1

Select one topic or subtopic of interest.

- |   |  |
|---|--|
| <input type="radio"/> News              | <input type="radio"/> Business             |
| <input type="radio"/> World             | <input type="radio"/> Marketing            |
| <input type="radio"/> National          | <input type="radio"/> Banking & Finance    |
| <input type="radio"/> Editorial         | <input type="radio"/> e-Commerce           |
| <input type="radio"/> Careers           | <input type="radio"/> Science & Tech.      |
| <input type="radio"/> Consulting        | <input type="radio"/> Computing & Internet |
| <input type="radio"/> Small/Home Office | <input type="radio"/> Energy/Environment   |
| <input type="radio"/> Taxes & Estates   | <input type="radio"/> Medical              |
| <input type="radio"/> Training          | <input type="radio"/> Telecommunications   |
| <input type="radio"/> Sports            | <input type="radio"/> Leisure              |
| <input type="radio"/> Baseball          | <input type="radio"/> Arts & Entertainment |
| <input type="radio"/> Basketball        | <input type="radio"/> Fashion & Shopping   |
| <input type="radio"/> Football          | <input type="radio"/> Food & Wine          |
| <input type="radio"/> Golf              | <input type="radio"/> Health & Fitness     |
| <input type="radio"/> Soccer            | <input type="radio"/> Travel & Vacations   |

You may also enter one or more  
keywords to restrict your choice  
of topic or subtopic:

Click here to

Fig. 5H

## Step 7

Select a category of advertising  
you prefer for your newspaper.

- |   |                                       |
|---|---------------------------------------|
| <input type="radio"/> Auto              | <input type="radio"/> Real Estate     |
| <input type="radio"/> Health & Fitness  | <input type="radio"/> Travel          |
| <input type="radio"/> Sports            | <input type="radio"/> Entertainment   |
| <input type="radio"/> Investments       | <input type="radio"/> Science & Tech. |
| <input type="radio"/> Men               | <input type="radio"/> Women           |
| <input type="radio"/> Teens             | <input type="radio"/> Family          |
| <input type="radio"/> College           | <input type="radio"/> Shopping        |
| <input type="radio"/> Job Opportunities | <input type="radio"/> Food            |
| <input type="radio"/> Sports            | <input type="radio"/> Wine            |

You may also enter one or more  
keywords to restrict your choice of  
advertising:

Click here to

Fig. 5I

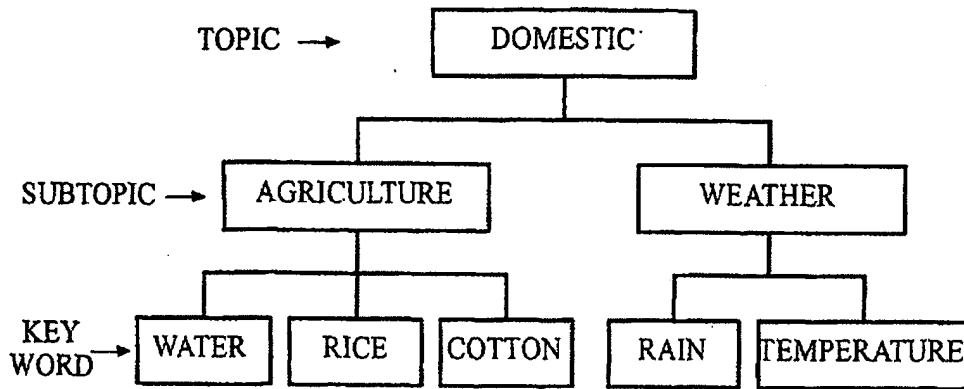

Fig. 6A

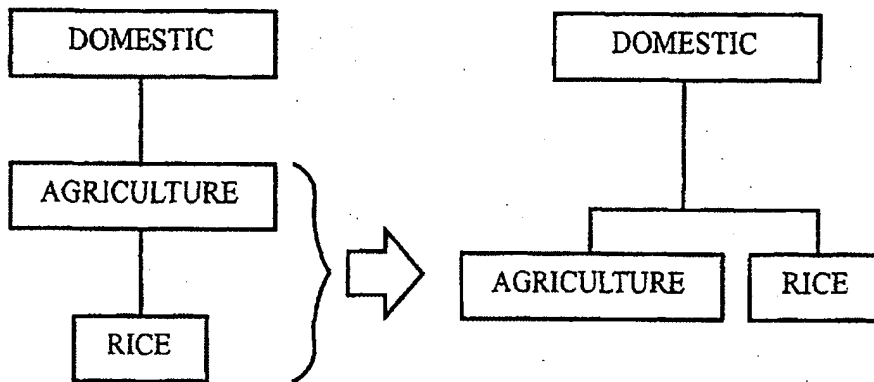

Fig. 6B

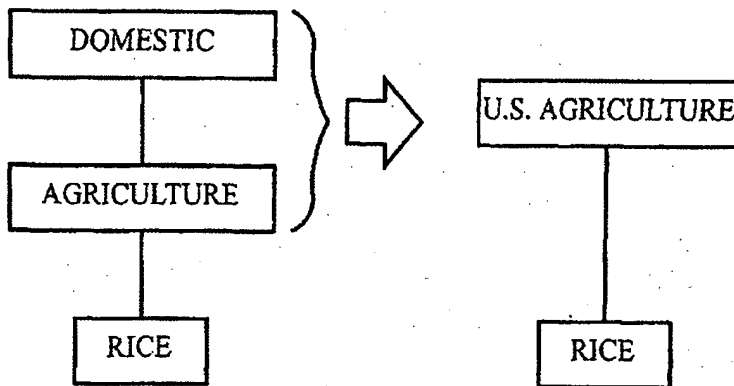

Fig. 6C

## Article Selection

Please select all of the articles you wish to see in your next newspaper.

Topic/Subtopic: Arts & Entertainment

- Bette Midler TV show will battle 'Who Wants to Be a Millionaire'
- Photo: Bette Midler takes on 'Millionaire'
- Networks scramble to solve the mystery of Friday night programming
- Advertisement: Conk Out -- Acme Pharmaceuticals unveils new sleeping aid.
- Rigby brings joy of being a boy to TV musical 'Peter Pan'

ALL

CLEAR

Click here to select all articles in the list.

Click here to clear all of your selections

Click here to receive your newspaper:

GO

Fig. 7

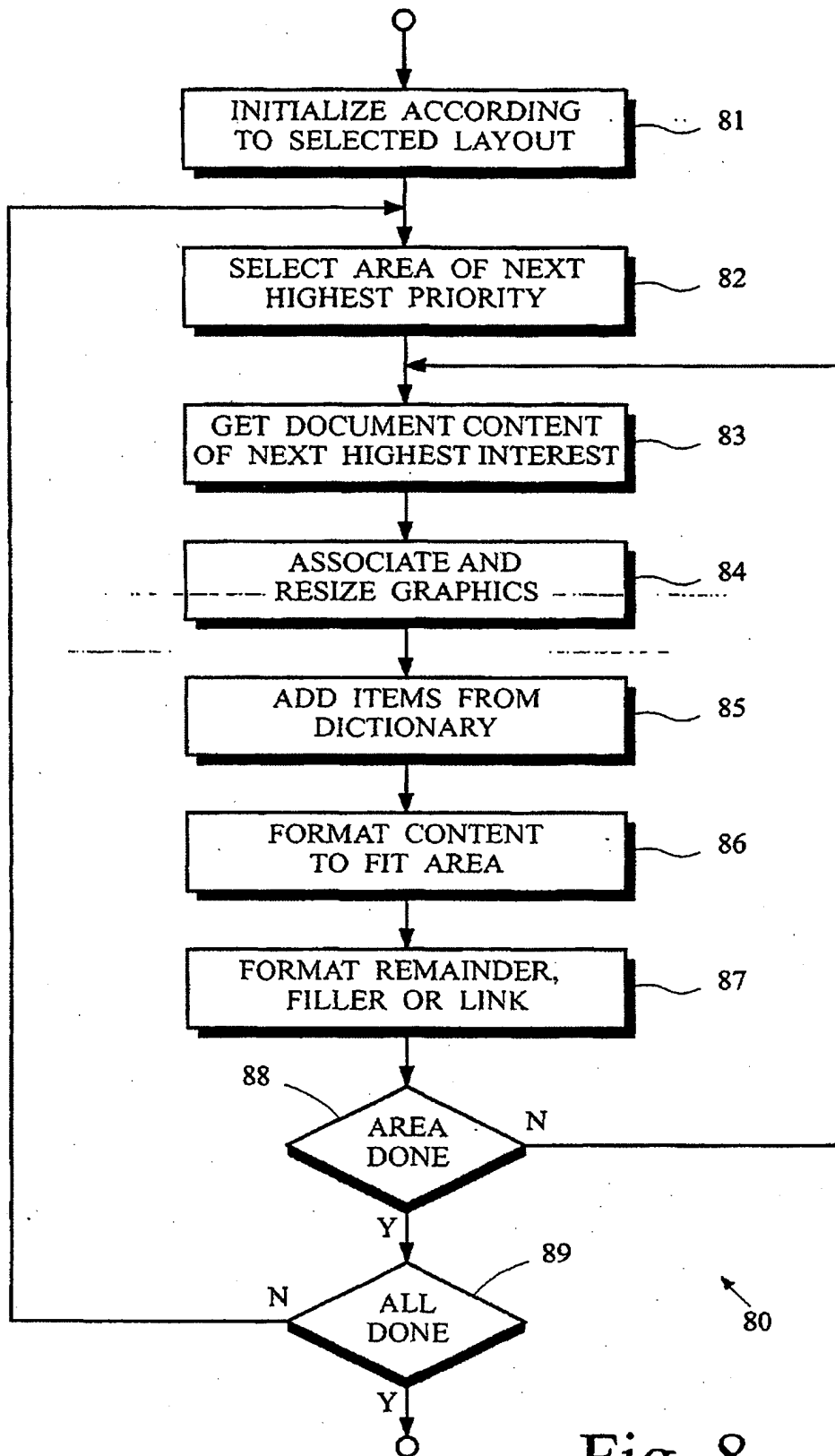

Fig. 8

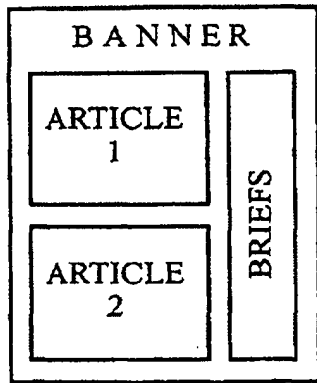

Fig. 9A

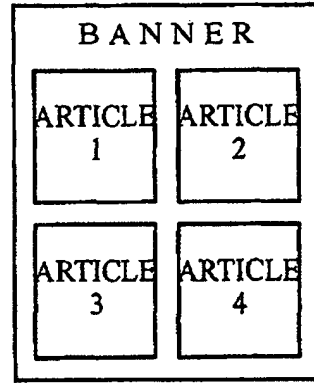

Fig. 9B

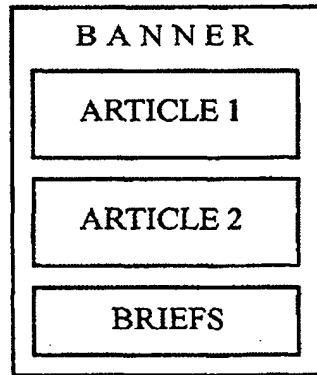

Fig. 9C

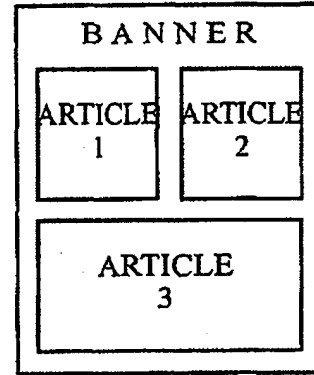

Fig. 9D

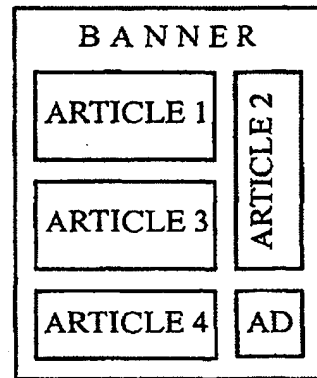

Fig. 9E

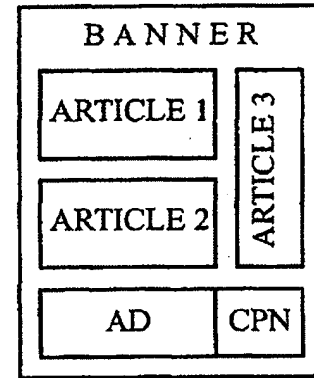

Fig. 9F



(12) EUROPEAN PATENT APPLICATION

(88) Date of publication A3:  
 18.08.2004 Bulletin 2004/34

(51) Int Cl.7: G06F 17/30

(43) Date of publication A2:  
 30.01.2002 Bulletin 2002/05

(21) Application number: 01118284.7

(22) Date of filing: 30.07.2001

(84) Designated Contracting States:  
 AT BE CH CY DE DK ES FI FR GB GR IE IT LI LU  
 MC NL PT SE TR  
 Designated Extension States:  
 AL LT LV MK RO SI

(72) Inventors:  
 • Miyasaka, Hitoshi  
 Mountain View, California 94041 (US)  
 • Tanaka, Toshio  
 Shiojiri-shi, Nagano-ken 399-0711 (JP)

(30) Priority: 28.07.2000 US 627350  
 01.11.2000 US 705125

(74) Representative: Grünecker, Kinkeldey,  
 Stockmair & Schwanhäusser Anwaltssozietät  
 Maximilianstrasse 58  
 80538 München (DE)

(71) Applicant: SEIKO EPSON CORPORATION  
 Tokyo 163 (JP)

(54) Providing a network-based personalized newspaper with personalized content and layout

(57) A computer network server provides a customized newspaper to a recipient according to recipient profile preferences. The server searches for and obtains article content that is deemed to be of greatest interest to the recipient according to topical preferences, generates a representation of the selected content according to a layout preference, and delivers the representation

to the recipient according to a designated schedule. Recipient preferences are received and stored in a profile database using facilities that assist a recipient to specify preferred topics, newspaper layout, delivery schedule and destination. Topical designations are mapped into hierarchical structures that facilitate searching content databases. Newspaper articles are arranged according to relative priorities of designated topics.

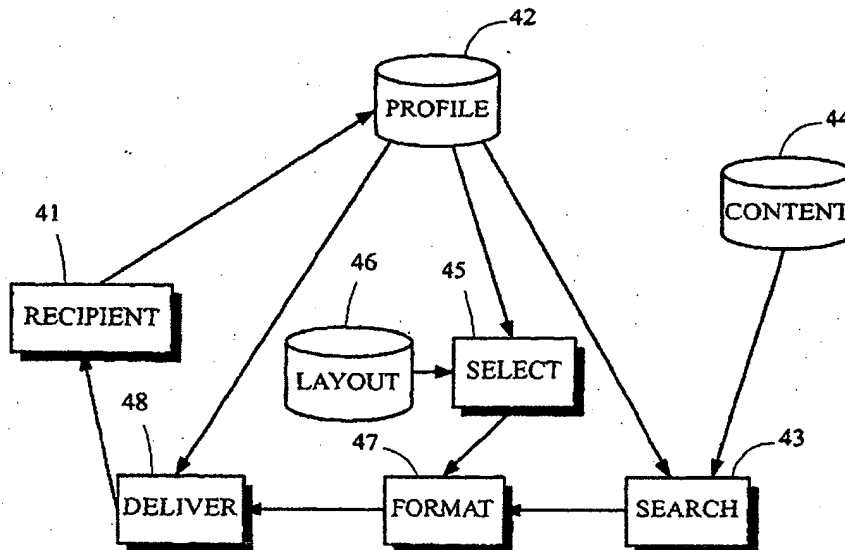

Fig. 1B



European Patent Office

EUROPEAN SEARCH REPORT

Application Number  
EP 01 11 8284

DOCUMENTS CONSIDERED TO BE RELEVANT			
Category	Citation of document with indication, where appropriate, of relevant passages	Relevant to claim	CLASSIFICATION OF THE APPLICATION (Int.Cl.7)
X	EP 0 834 822 A (CANON INFORMATION SYST INC) 8 April 1998 (1998-04-08) * claims 11-15 *	1-64	G06F17/30
X	G. J. F. JONES, D.J. QUESTED, K. E. THOMSON: "Personalised Delivery of News Articles from Multiple Sources" LECTURE NOTES ON COMPUTER SCIENCE, vol. 1923, 2000, pages 340-343, XP002274101 Berlin Heidelberg * paragraph [0003]; figures 1,2 *	1-64	
X	WO 99/33293 A (GLOBAL MOBILITY SYSTEMS INC) 1 July 1999 (1999-07-01) * abstract *	1-64	
Y	WO 97/27534 A (COMPUSERVE INC) 31 July 1997 (1997-07-31) * abstract *	1-64	
Y	US 5 907 838 A (MIWA SHINJI ET AL) 25 May 1999 (1999-05-25) * abstract *	1-64	
A	CHOY D M ET AL: "Services and architectures for electronic publishing" DIGEST OF PAPERS OF COMPCON (COMPUTER SOCIETY CONFERENCE) 1996 TECHNOLOGIES FOR THE INFORMATION SUPERHIGHWAY. SANTA CLARA, FEB. 25 - 28, 1996, DIGEST OF PAPERS OF THE COMPUTER SOCIETY COMPUTER CONFERENCE COMPCON, LOS ALAMITOS, IEEE COMP. SOC. PRESS, , XP010160911 ISBN: 0-8186-7414-8 * the whole document *	1-64	TECHNICAL FIELDS SEARCHED (Int.Cl.7) G06F
-The present search report has been drawn up for all claims			
Place of search Munich		Date of completion of the search 19 March 2004	Examiner May, M
CATEGORY OF CITED DOCUMENTS X : particularly relevant if taken alone Y : particularly relevant if combined with another document of the same category A : technological background O : non-written disclosure P : intermediate document		T : theory or principle underlying the invention E : earlier patent document, but published on, or after the filing date D : document cited in the application L : document cited for other reasons & : member of the same patent family, corresponding document	

EPO FORM 1503 03/02 (P04031)





European Patent  
Office

Application Number

EP 01 11 8284

**CLAIMS INCURRING FEES**

The present European patent application comprised at the time of filing more than ten claims.

- Only part of the claims have been paid within the prescribed time limit. The present European search report has been drawn up for the first ten claims and for those claims for which claims fees have been paid, namely claim(s):
- No claims fees have been paid within the prescribed time limit. The present European search report has been drawn up for the first ten claims.

**LACK OF UNITY OF INVENTION**

The Search Division considers that the present European patent application does not comply with the requirements of unity of invention and relates to several inventions or groups of inventions, namely:

see sheet B

- All further search fees have been paid within the fixed time limit. The present European search report has been drawn up for all claims.
- As all searchable claims could be searched without effort justifying an additional fee, the Search Division did not invite payment of any additional fee.
- Only part of the further search fees have been paid within the fixed time limit. The present European search report has been drawn up for those parts of the European patent application which relate to the inventions in respect of which search fees have been paid, namely claims:
- None of the further search fees have been paid within the fixed time limit. The present European search report has been drawn up for those parts of the European patent application which relate to the invention first mentioned in the claims, namely claims:

1-64



The Search Division considers that the present European patent application does not comply with the requirements of unity of invention and relates to several inventions or groups of inventions, namely:

1. claims: 1-64

A system for providing a personalized electronic newspaper via pull technology: the problem to be solved seems to be how to provide personalized information in a search engine with relevance feedback

---

2. claims: 65-144

A system for providing a personalized electronic newspaper via push technology: the problem to be solved seems to be how to provide personalized information in a subscription automatically

---

ANNEX TO THE EUROPEAN SEARCH REPORT  
ON EUROPEAN PATENT APPLICATION NO.

EP 01 11 8284

This annex lists the patent family members relating to the patent documents cited in the above-mentioned European search report. The members are as contained in the European Patent Office EDP file on  
The European Patent Office is in no way liable for these particulars which are merely given for the purpose of information.

19-03-2004

Patent document cited in search report		Publication date	Patent family member(s)	Publication date
EP 0834822	A	08-04-1998	US 6029182 A	22-02-2000
			EP 0834822 A2	08-04-1998
			JP 10254912 A	25-09-1998
-----				
WO 9933293	A	01-07-1999	AU 1921799 A	12-07-1999
			BR 9814503 A	16-07-2002
			CA 2316386 A1	01-07-1999
			EP 1042933 A1	11-10-2000
			JP 2002517918 T	18-06-2002
			WO 9933293 A1	01-07-1999
-----				
WO 9727534	A	31-07-1997	US 6065047 A	16-05-2000
			AU 1708397 A	20-08-1997
			CA 2244787 A1	31-07-1997
			EP 0876644 A1	11-11-1998
			WO 9727534 A1	31-07-1997
-----				
US 5907838	A	25-05-1999	JP 10228488 A	25-08-1998
			US 6070162 A	30-05-2000
-----				

**This Page is Inserted by IFW Indexing and Scanning  
Operations and is not part of the Official Record**

**BEST AVAILABLE IMAGES**

Defective images within this document are accurate representations of the original documents submitted by the applicant.

Defects in the images include but are not limited to the items checked:

- BLACK BORDERS
- IMAGE CUT OFF AT TOP, BOTTOM OR SIDES
- FADED TEXT OR DRAWING
- BLURRED OR ILLEGIBLE TEXT OR DRAWING
- SKEWED/SLANTED IMAGES
- COLOR OR BLACK AND WHITE PHOTOGRAPHS
- GRAY SCALE DOCUMENTS
- LINES OR MARKS ON ORIGINAL DOCUMENT
- REFERENCE(S) OR EXHIBIT(S) SUBMITTED ARE POOR QUALITY
- OTHER: \_\_\_\_\_

**IMAGES ARE BEST AVAILABLE COPY.**

**As rescanning these documents will not correct the image problems checked, please do not report these problems to the IFW Image Problem Mailbox.**